

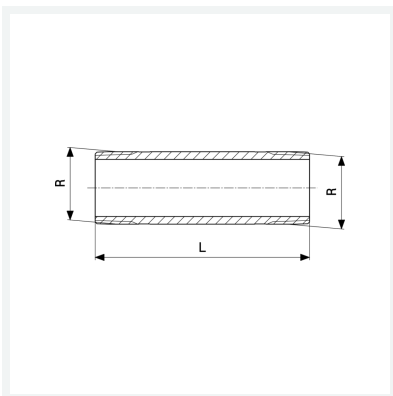

Langnippel
- R-Gewinde
Modell 3530

Artikel 319 724



Eigenschaften

Länge	L	180
Außengewinde kegelig	R	½
Länge	L	180 mm
Gewicht	310 g	
Volumen	155,4 cm ³	
Werkstoff	Rotguss oder Siliziumbronze	