

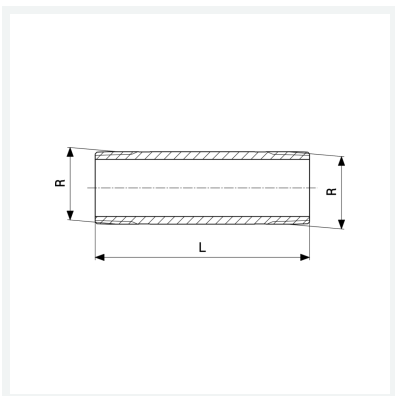

Langnippel
- R-Gewinde
Modell 3530

Artikel 267 407



Eigenschaften

Länge	L	80
Außengewinde kegelig	R	¾
Länge	L	80 mm
Gewicht	166,7 g	
Volumen	165,76 cm ³	
Werkstoff	Rotguss oder Siliziumbronze	