

ELECTRIC ACTUATOR

4C 140



GENERAL CHARACTERISTICS

Housing: Anticorrosive polyamide (lid & body)
 Main external shaft: stainless steel
 External screws: stainless steel
 Gears: Steel and polyamide
 Visual position indicator: Polyamide
 Dome: Polycarbonate
 Adjustable internal cams: Polyamide
 Electric motor: 24VDC Brushless motor
 Insulation: Class B
 (IEC 60034) Service: S4



DATASHEET

Model	STD.140	ALT.140
Voltage VDC/VAC 50/60Hz -0/+5%	24 a 240 (Patent Pending)	12 V ONLY
Operation time unload	25 Sec./90°	25 Sec./90°
Maximum torque break	170 Nm / 1504,5 lb/in	170 Nm / 1504,5 lb/in
Maximum operational torque	140 Nm / 1239 lb/in	140 Nm / 1239 lb/in
Duty rating	75 %	75 %
Max. Working angle	0° to 270°	0° to 270°
Limit switch	4 SPST NO micro (2 motor stop and 2 confirmations)	4 SPST NO micro (2 motor stop and 2 confirmations)
Automatic heater	3,5 W	3,5 W
Big Plug	EN175301-803 FORM A	EN175301-803 FORM A
Small Plug	DIN43650/C	DIN43650/C
Protection IEC 60529 rating	IP67	IP67
Temperature	-20°C +70°C / -4°F +158°F	-20°C +70°C / -4°F +158°F
Weight	5,2 Kg	5,2 Kg



VALVE CONNECTION

ISO 5211 Plate : F07/F10
 DIN 3337 Female output drive : *22 mm

Option:
 ISO 5211 Plate : F12
 DIN 3337 Female output drive: *17 mm



OPTIONS

-4C 140/300 DPS digital positioner: 4 -20mA, 0-20mA, 0-10V or 1-10V.
 -4C 140/300 BSR emergency fail safe kit system by battery
 -Digital potentiometer: 1K, 5K or 10K.
 -3 position actuator: 0°-45°-90° or 0°-90°-180°

4C 140 SIZES

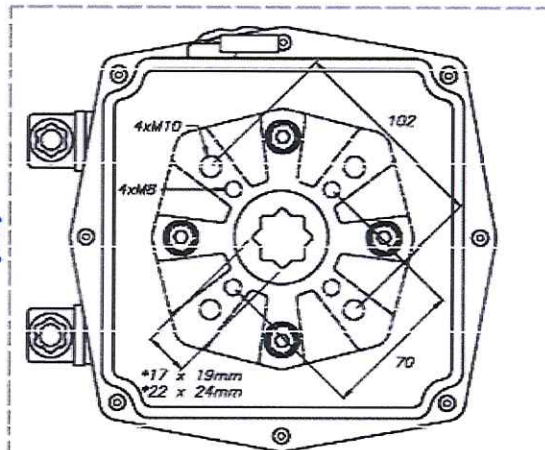
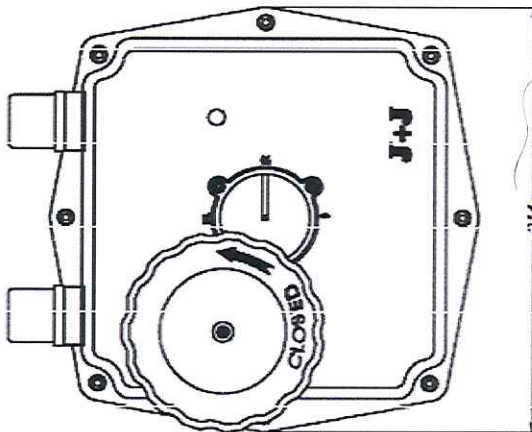
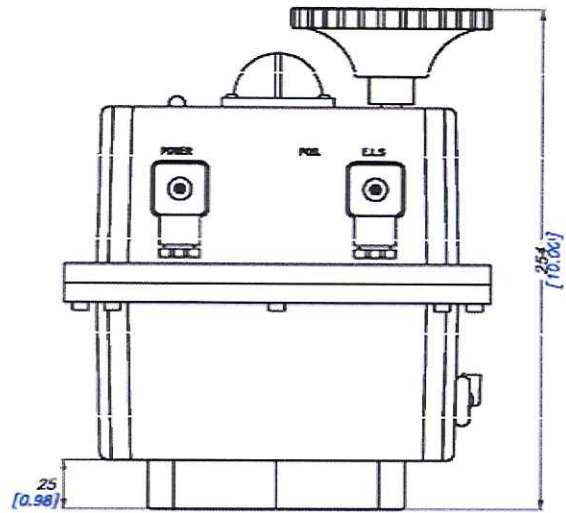
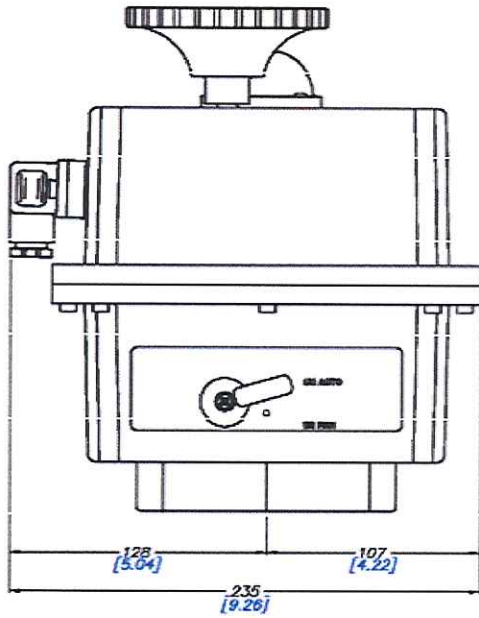

EXTERNAL CONNECTING DIAGRAM

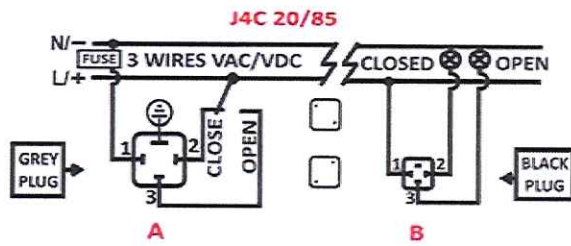

3 WIRES ON - OFF

A = Power supply plug

A: VAC 3 WIRES (Grey plug)

PIN 1 = Neutral + PIN 2 = Phase = Close

PIN 1 = Neutral + PIN 3 = Phase = Open

A: VDC 3 WIRES (Grey plug)

PIN 1 = (-) Negative + PIN 2 = (+) Positive = Close

PIN 1 = (-) Negative + PIN 3 = (+) Positive = Open

B = Volt free contact, plug

PIN 1 / PIN 2 = Close

PIN 1 / PIN 3 = Open

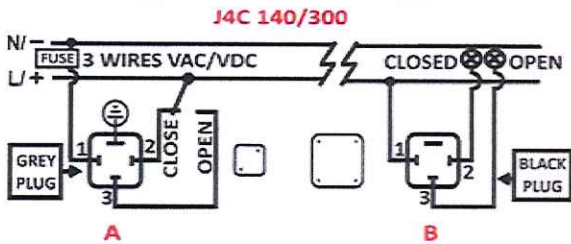

2 WIRES ON - OFF

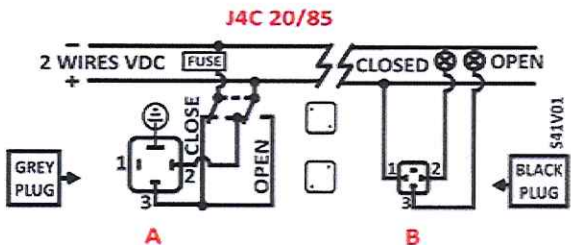

A = Power supply plug

A: VDC 2 WIRES (Grey plug)

PIN 2 = (+) Positive + PIN 3 = (-) Negative = Close

PIN 2 = (-) Negative + PIN 3 = (+) Positive = Open

B = Volt free contact plug

PIN 1 / PIN 2 = Close

PIN 1 / PIN 3 = Open

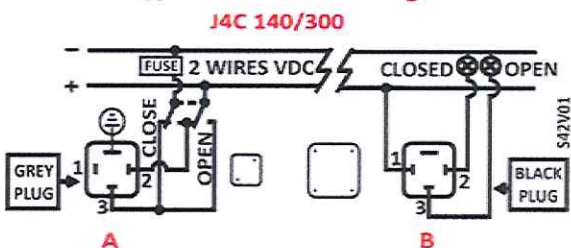

POSITIONER

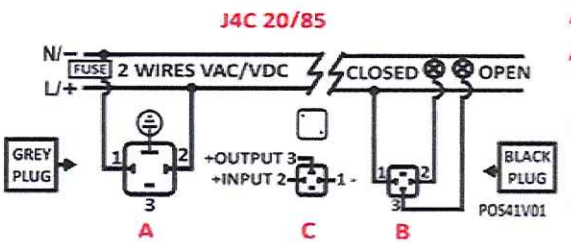

A = Power supply plug

A: VAC 2 WIRES (Grey plug)

PIN 1 = Neutral + PIN 2 = Phase = Power supply plug

A: VDC 2 WIRES (Grey plug)

PIN 1 = (-) Negative + PIN 2 = (+) Positive = Power supply plug

B = Volt free contact plug

PIN 1 / PIN 2 = Closed

PIN 1 / PIN 3 = Open

C = Instrumentation Signal

C: Input signal : 4/20mA or 0/10V

PIN 1 = (-) Negative + PIN 2 = (+) Positive = Input signal

PIN 1 = (-) Negative + PIN 3 = (+) Positive = Output signal

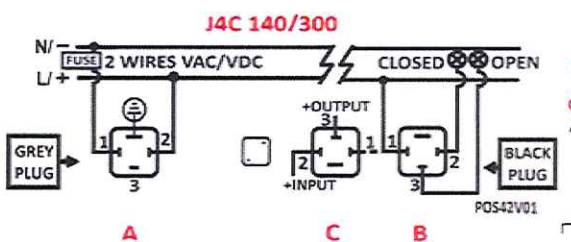

 **Instrumentation Signal
NO VOLTAGE**

TABLE OF CONSUMPTIONS

J4C 20 Consumption		Unload		Max. Operational Torque 20Nm		Max. Torque Break 25Nm	
Voltage	Model	A	W	A	W	A	W
12 VDC	B20	0,75	9,06	1,80	21,60	1,95	23,36
24 VDC	S20	0,45	10,77	0,90	21,49	0,97	23,39
48 VDC	S20	0,21	9,93	0,42	20,38	0,46	22,07
110 VDC	S20	0,07	8,00	0,13	14,30	0,14	15,70
12 VAC	B20	1,04	12,51	1,85	22,18	2,28	27,32
24 VAC	S20	0,59	14,20	1,12	26,77	1,28	30,62
48 VAC	S20	0,34	16,37	0,69	33,16	0,75	36,22
110 VAC	S20	0,14	15,73	0,27	29,52	0,30	32,67
240 VAC	S20	0,10	23,76	0,15	36,43	0,16	39,07

J4C 35 Consumption		Unload		Max. Operational Torque 35Nm		Max. Torque Break 38Nm	
Voltage	Model	A	W	A	W	A	W
12 VDC	B20	0,75	9,06	2,38	28,62	2,62	31,50
24 VDC	S20	0,45	10,77	1,28	30,78	1,37	32,79
48 VDC	S20	0,21	9,93	0,56	26,72	0,59	28,20
110 VDC	S20	0,07	7,70	0,17	18,90	0,18	20,10
12 VAC	B20	1,04	12,51	2,75	33,00	3,19	38,28
24 VAC	S20	0,59	14,20	1,58	37,80	1,67	40,13
48 VAC	S20	0,34	16,37	0,92	44,04	0,99	47,31
110 VAC	S20	0,14	15,73	0,36	39,45	0,38	41,87
240 VAC	S20	0,10	23,76	0,19	45,41	0,20	47,52

J4C 55 Consumption		Unload		Max. Operational Torque 55Nm		Max. Torque Break 60Nm	
Voltage	Model	A	W	A	W	A	W
12 VDC	B20	0,70	8,45	3,04	36,43	3,42	41,05
24 VDC	S20	0,42	10,19	1,55	37,17	1,63	39,02
48 VDC	S20	0,20	9,72	0,61	29,25	0,67	32,31
110 VDC	S20	0,07	7,50	0,19	20,80	0,21	23,20
12 VAC	B20	0,94	11,30	3,43	41,18	3,78	45,41
24 VAC	S20	0,58	13,89	1,87	44,88	1,98	47,52
48 VAC	S20	0,33	15,73	1,10	52,80	1,21	58,29
110 VAC	S20	0,14	15,73	0,40	43,80	0,43	46,95
240 VAC	S20	0,09	22,70	0,20	47,52	0,21	50,16

J4C 85 Consumption		Unload		Max. Operational Torque -85Nm		Max. Torque Break -90Nm	
Voltage	Model	A	W	A	W	A	W
12 VDC	B20	0,62	7,42	2,11	25,34	2,28	27,32
24 VDC	S20	0,36	8,55	1,08	25,87	1,22	29,30
48 VDC	S20	0,17	8,24	0,48	22,92	0,53	25,56
110 VDC	S20	0,05	5,80	0,14	15,20	0,16	17,90
12 VAC	B20	0,81	9,69	2,38	28,51	2,65	31,81
24 VAC	S20	0,50	11,88	1,36	32,74	1,50	36,01
48 VAC	S20	0,25	11,83	0,77	37,07	0,86	41,18
110 VAC	S20	0,12	12,83	0,31	33,64	0,33	36,54
240 VAC	S20	0,08	20,06	0,17	40,13	0,18	42,77

J4C 140 Consumption		Unload		Max. Operational Torque 140Nm		Max. Torque Break 170Nm	
Voltage	Model	A	W	A	W	A	W
12 VDC	B140	1,93	23,10	4,73	56,76	5,39	64,68
24 VDC	S140	0,66	15,84	2,15	51,48	2,53	60,72
48 VDC	S140	0,30	14,25	0,88	42,24	1,10	52,80
110 VDC	S140	0,10	10,89	0,28	30,25	0,39	42,35
12 VAC	B140	2,75	33,00	6,60	79,20	8,47	101,64
24 VAC	S140	0,83	19,80	2,59	62,04	3,30	79,20
48 VAC	S140	0,48	23,23	1,43	68,64	1,79	86,06
110 VAC	S140	0,23	25,41	0,63	68,97	0,72	78,65
240 VAC	S140	0,18	42,24	0,39	90,40	0,44	105,60

J4C 300 Consumption		Unload		Max. Operational Torque 300Nm		Max. Torque Break 350Nm	
Voltage	Model	A	W	A	W	A	W
12 VDC	B300	1,32	15,84	5,17	62,04	5,45	65,34
24 VDC	S300	0,50	11,88	2,31	55,44	2,70	64,68
48 VDC	S300	0,22	10,56	1,10	52,80	1,19	57,02
110 VDC	S300	0,09	9,68	0,33	36,30	0,39	42,35
12 VAC	B300	1,98	23,76	7,26	87,12	8,64	103,62
24 VAC	S300	0,66	15,84	2,75	66,00	3,30	79,20
48 VAC	S300	0,36	17,42	1,65	79,20	1,87	89,76
110 VAC	S300	0,19	20,57	0,66	72,60	0,77	84,70
240 VAC	S300	0,15	36,96	0,42	100,32	0,47	113,52