





















Update: 01/2024

 ACCIAIO INOX AISI 316L STAINLESS STEEL AISI 316L EDELSTAHL AISI 316L		 15-108
 Germany	  **	
 France	 	
 Austria	 *	
 Norway	  *	
 Sweden		
 Netherlands		
 Switzerland		
 Denmark	  *	
 Russia		
 Italy	 	
 Czech Rep.	 * 	
 Australia	  *	
 Poland	   *	
 USA		

 ACCIAIO INOX GAS AISI 316L STAINLESS STEEL GAS AISI 316L EDELSTAHL GAS AISI 316L	
 Germany	
 Austria	 *

 ACCIAIO AL CARBONIO CARBON STEEL C-STAHL	
 Germany	 **
 France	 *
 Sweden	
 Czech Rep.	 * 
 Poland	  *
 Australia	 *

* Omologazione ottenuta direttamente dal distributore.

Approval obtained directly by our distributor.

Inhaber der Zulassung ist unser Vertreter.

** Gamma omologata **VdS** da Ø22 a Ø108 mm, valida esclusivamente per l'utilizzo abbinato di tubi e raccordi Eurotubi Europa.

VdS approved range from Ø22 to Ø108 mm, valid only for the combined use of Eurotubi Europa pipes and fittings.

VdS zugelassen von Ø22 - 108 mm, gilt ausschliesslich bei Verwendung von Eurotubi Fittings kombiniert mit Eurotubi Europa Rohren.

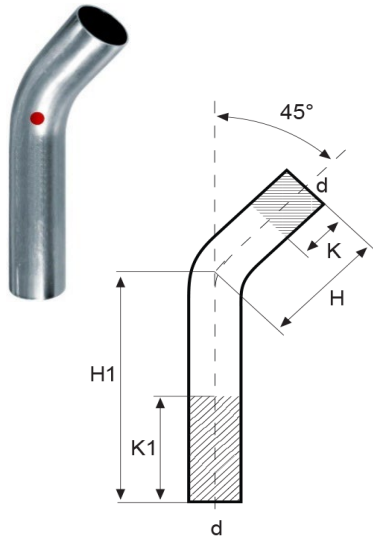
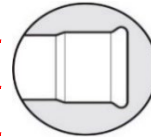

Tubo curvo 45°

Bend 45° with plain ends

Passbogen 45°

Code	d	H1	H	K	K1			MOQ
C73AB	12	120	62	19	77	70	20	20
C73AC	15	120	62	19	77	92	20	20
C73AD	18	124	58	16	82	88	20	20
C73AE	22	120	56	7	71	130	10	20
C73AF	28	122	58	2	66	170	10	20
C73AG	35	206	94	20	132	366	6	12
C73AH	42	262	114	1	149	538	4	8
C73AJ	54	321	146	37	212	889	1	8
C73AK	76,1	225	225	69	69	1.660	1	3
C73AL	88,9	267	267	103	103	2.270	1	3
C73AM	108	293	293	66	66	3.022	1	3

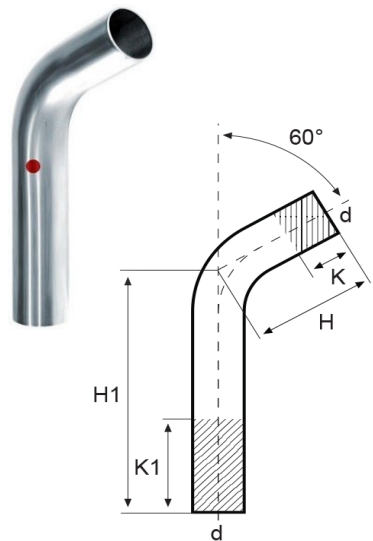

Tubo curvo 60°

Bend 60° with plain ends

Passbogen 60°

Code	d	H1	H	K	K1			MOQ
C72AB	12	122	60	21	83	70	20	20
C72AC	15	122	60	21	83	90	20	20
C72AD	18	122	62	16	76	110	20	20
C72AE	22	118	60	5	63	130	10	20
C72AF	28	116	71	7	47	176	10	10
C72AG	35	226	101	30	110	396	8	8
C72AH	42	251	124	44	145	544	4	8
C72AJ	54	308	162	65	165	857	1	8
C72AK	76,1	219	223	70	70	1.537	1	3
C72AL	88,9	250	257	80	80	2.090	1	3
C72AM	108	288	298	95	95	2.542	1	3

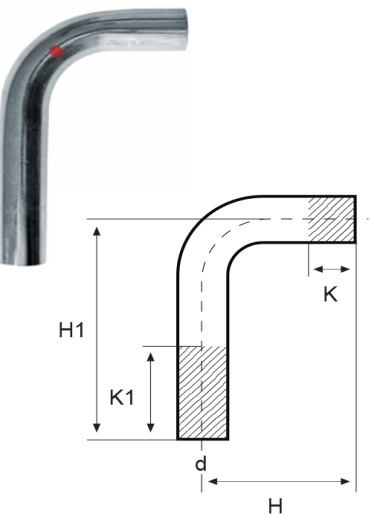

Tubo curvo 90°

Bend 90° with plain ends

Passbogen 90°

Code	d	H1	H	K	K1			MOQ
C70AB	12	120	70	17	67	70	20	80
C70AC	15	120	70	22	72	90	20	80
C70AD	18	120	70	17	67	100	20	60
C70AE	22	120	70	9	59	126	10	60
C70AF	28	125	97	7	47	191	10	40
C70AG	35	201	121	62	62	359	8	24
C70AH	42	254	160	90	90	530	4	24
C70AJ	54	302	202	45	45	867	1	20
C70AK	76,1	250	250	62	60	1.634	1	5
C70AL	88,9	291	291	90	90	2.240	1	5
C70AM	108	364	364	45	45	3.170	1	5