

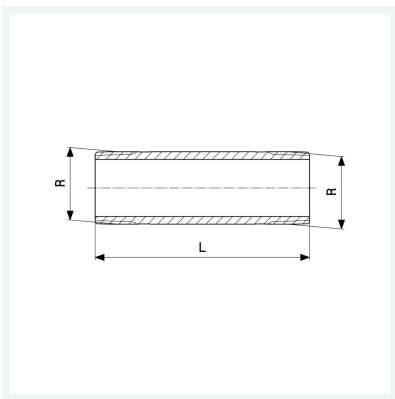

Langnippel
- R-Gewinde
Modell 3530

Artikel 319 694



Eigenschaften

Länge	L	200
Außengewinde kegelig	R	1
Länge	L	200 mm
Gewicht	593,8 g	
Volumen	497,28 cm ³	
Werkstoff	Rotguss oder Siliziumbronze	