

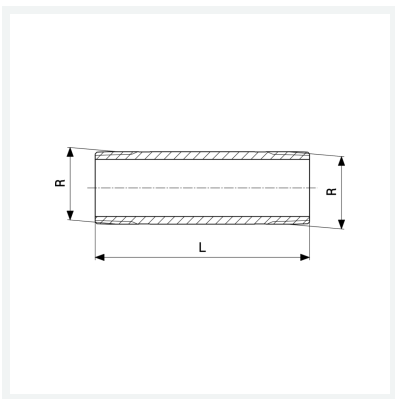

Langnippel
- R-Gewinde
Modell 3530

Artikel 267 445



Eigenschaften

Länge	L	200
Außengewinde kegelig	R	¾
Länge	L	200 mm
Gewicht	435,66 g	
Volumen	310,8 cm ³	
Werkstoff	Rotguss oder Siliziumbronze	