

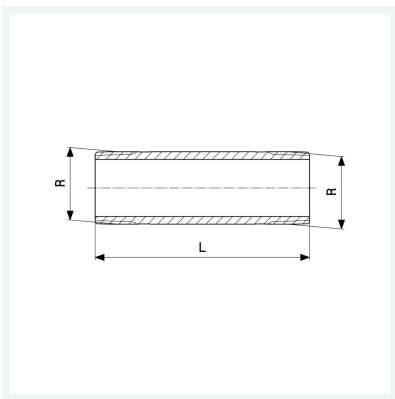

Langnippel
- R-Gewinde
Modell 3530

Artikel 282 424



Eigenschaften

Länge	L	80
Außengewinde kegelig	R	$\frac{3}{8}$
Länge	L	80 mm
Gewicht	99 g	
Volumen	62,16 cm ³	
Werkstoff	Rotguss oder Siliziumbronze	