

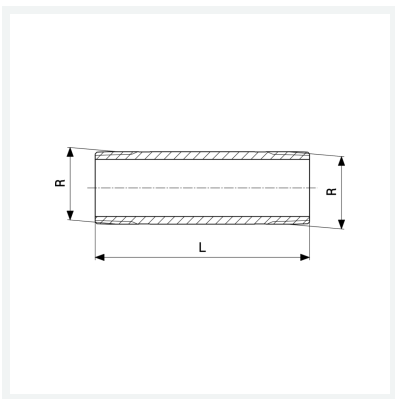

**Langnippel**  
- R-Gewinde  
**Modell 3530**

**Artikel 267 384**



## Eigenschaften

Länge	L	40
Außengewinde kegelig	R	¾
Länge	L	40 mm
Gewicht	71,7 g	
Volumen	62,16 cm <sup>3</sup>	
Werkstoff	Rotguss oder Siliziumbronze	