

BENNING

Quick reference guide

Translation of the German original version

BENNING IT 115

IDNR 20752416 / 5282 / 03/2023 en



Legal notice

Notes on the quick reference guide

This printed quick reference guide is only an excerpt from the detailed operating manual of the installation tester BENNING IT 115. The latest version of the operating manual can be found on the product website of the BENNING IT 115 for free download in PDF format.

<http://tms.benning.de/it115>



The devices are subject to continuous further development. Benning reserves the right to make changes to the device's design, configuration and technology. The information in this operating manual corresponds to the state of technical knowledge at the time of printing. For this reason, no claims for certain device characteristics can be derived from the contents of this operating manual.

Manufacturer / holder of rights

BENNING Elektrotechnik und Elektronik GmbH & Co. KG

Münsterstraße 135 – 137

46397 Bocholt

Germany

Phone: +49 2871 / 93-0

General non-discrimination

Benning is aware of the importance of language with regard to the gender equality and endeavors to take this into account at all times. To improve readability, we have refrained from consistently using differentiating formulations.

Copyright

© Copyright 2020, BENNING Elektrotechnik und Elektronik GmbH & Co. KG

All rights reserved.

This document – particularly all of the contents, texts, photographs and graphics that it contains – are protected by copyright.

No part of this documentation or the associated contents may be reproduced or edited, copied or distributed using electronic media in any form (printed, photocopied or using any other method) without express written permission.

Information in this operating manual can be changed at any time without prior notice. Benning is not obligated to make amendments to this operating manual or to keep it up to date. The devices are subject to continuous further development. Benning reserves the right to make changes to the device's design, configuration and technology.

IDNR. 20752416
TN: 10141999.06

Table of Contents

1	Start-up guide.....	4
1.1	Safety and operational considerations	4
1.2	Front and connector panel.....	6
1.3	Standard scope of delivery	7
1.4	Indications and meaning of symbols	8
1.5	Selecting measuring functions.....	9
1.6	Settings.....	10
1.7	Batteries and fuses.....	10
1.8	Calibration.....	12
1.9	Service & support	12
1.10	Disposal and environmental protection	12
1.11	Optional accessories	13
2	Measurements.....	14
2.1	Null balance (compensation) of the test cables.....	14
2.2	TRMS voltage (V AC/DC), frequency and phase sequence (rotary field).....	15
2.3	Insulation Resistance (R_{ISO})	16
2.4	Low-impedance resistance (R_{LOW}) / continuity test	17
2.5	Residual current operated device (RCD)	18
2.6	Loop impedance ($Z_{S L-PE}$)	19
2.7	Line impedance ($Z_{I L-N/L}$).....	20
2.8	Earth resistance (R_E)	21

1 Start-up guide

1.1 Safety and operational considerations

The following symbols are used in the user manual and on the test equipment:



Important, danger, must comply with documentation!



Warning of electrical danger!



Protection class II



Ground (voltage to earth)



At the end of product life, dispose of the unserviceable device and the batteries via appropriate collecting facilities provided in your community.



The device complies with EU directives.



Warnings related to safety – general information

- ❑ This document is not a supplement to the operating manual! The operating manual can be found on the product website of the BENNING IT 115 for free download in PDF format.
<http://tms.benning.de/it115>
- ❑ If the test equipment is used in a manner not specified in this user manual, the protection provided by the equipment could be impaired!
- ❑ Read this user manual carefully, otherwise the use of the instrument may be dangerous for the operator, the instrument or for the equipment under test!
- ❑ Do not use the instrument or any of the accessories if any damage is noticed!
- ❑ Consider all generally known precautions in order to avoid risk of electric shock while dealing with hazardous voltages!
- ❑ If the fuse F1 has blown, please follow the instructions of this operating manual to replace it! Only use a fuse complying with the specification (see chapter 7.1) as replacement.
If one of the fuses F2 or F3 has blown, the device must not be used anymore. In this case, the device must be sent to BENNING for inspection and repair.
- ❑ Do not use the instrument in AC supply systems with voltages higher than 550 V AC.
- ❑ Service, repairs or adjustment of instruments and accessories is only allowed to be carried out by a competent authorized personnel!
- ❑ Please use standard or optional BENNING accessories only which are available from your authorized specialty retailer!
- ❑ Consider that protection category of some accessories is lower than of the instrument. Test tips and Tip "Commander" have removable caps. If they are removed the protection falls to CAT II. Check markings on accessories!
cap off, 18 mm tip: CAT II up to 1000 V to earth
cap on, 4 mm tip: CAT II 1000 V / CAT III 600 V / CAT IV 300 V to earth
- ❑ The instrument come supplied with rechargeable NiMh battery cells. The cells should only be replaced with the same type as defined on the battery compartment label or as described in this manual. Do not use standard alkaline battery cells while the power supply adapter is connected, otherwise they may explode!
- ❑ Hazardous voltages exist inside the instrument. Disconnect all test leads, remove the power supply cable and switch off the instrument before removing battery compartment cover.

- ❑ **All normal safety precautions must be taken in order to avoid risk of electric shock while working on electrical installations!**



Warnings related to safety – measurements

Insulation resistance

- ❑ Insulation resistance measurement should only be performed on de-energized objects!
- ❑ Do not touch the test object during the measurement or before it is fully discharged! Risk of electric shock!
- ❑ When an insulation resistance measurement has been performed on a capacitive object, automatic discharge may not be done immediately! The warning message  and the actual voltage (Udisch) are displayed during discharge until voltage drops below 30 V.
- ❑ Do not connect test terminals to external voltage higher than 600 V (AC or DC) in order not to damage the test instrument!

Low-impedance resistance/continuity test

- ❑ Low-impedance resistance measurements/ continuity tests should only be performed on de-energized objects!
- ❑ Parallel loops may influence on test results.

Testing PE terminal

- ❑ If the phase voltage is detected at the protective conductor connection PE, immediately stop all measurements and ensure that the fault of the installation will be eliminated.



Warnings related to safety – batteries/ storage batteries and fuses

- ❑ Disconnect all test cables / accessories from the tester and from the installation and switch the tester off before opening the cover of the battery / fuse compartment. Dangerous voltages may be applied to the interior of the tester!
- ❑ Please make sure that the storage batteries are inserted correctly, because otherwise the tester is not ready for operation and the storage batteries will discharge.
- ❑ Do not recharge alkaline battery cells!
- ❑ The storage batteries must be charged only by means of the charger included in the scope of delivery!



Warnings related to safety – "Commander" probe tip (optional) – "Commander" test plug for shock-proof socket (optional)

Measuring category of optional commanders:

"Commander" test probe, item no. 044155
(cap off, 18 mm tip)..... CAT II 1000 V to earth
(cap on, 4 mm tip)..... CAT II 1000 V / CAT III 600 V / CAT IV 300 V to earth

"Commander" test plug for shock-proof socket, item no. 044149
..... CAT II 300 V to earth

- ❑ Measuring category of commanders can be lower than protection category of the instrument.
- ❑ If dangerous voltage is detected on the tested PE terminal, immediately stop all measurements, find and remove the fault!
- ❑ Disconnect the "Commander" from the tester and from the installation and switch the "Commander" off before opening the cover of the battery compartment. Dangerous voltages might occur inside the "Commander"!

1.2 Front and connector panel

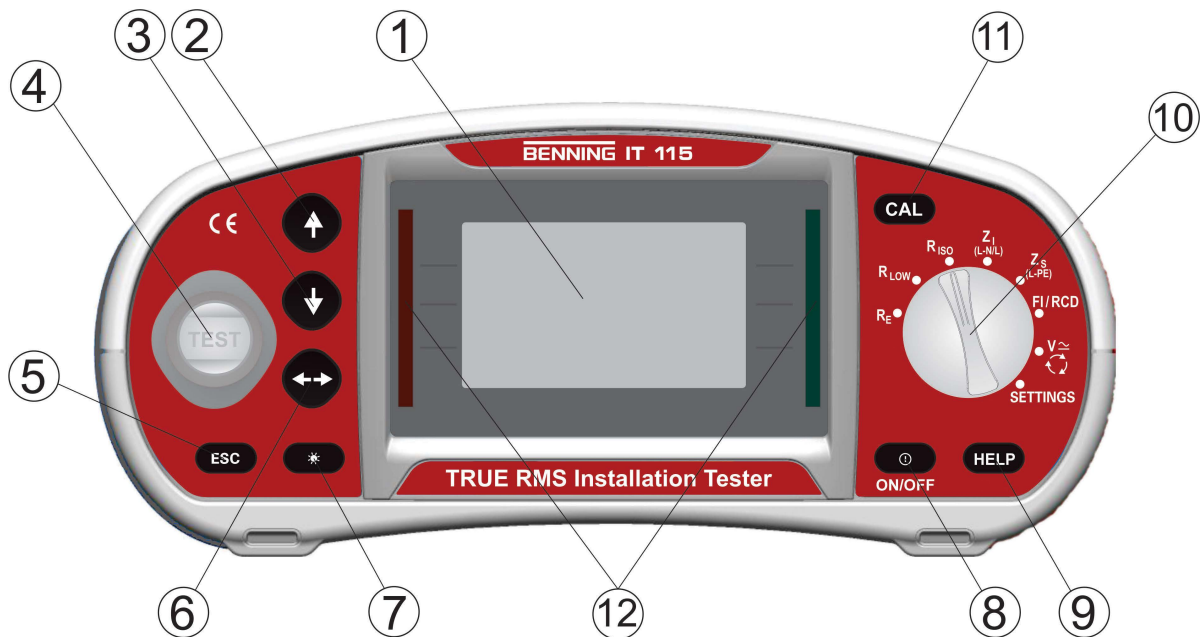

Legend:

1	LCD	<input type="checkbox"/> 128 x 64 dots matrix display with backlight.
2	UP	<input type="checkbox"/> Modifies selected parameter.
3	DOWN	<input type="checkbox"/> Starts measurements.
4	TEST	<input type="checkbox"/> Acts also as the PE touching electrode.
5	ESC	<input type="checkbox"/> Goes one level back.
6	TAB	<input type="checkbox"/> Selects the parameters in selected function.
7	Backlight, Contrast	<input type="checkbox"/> Changes backlight level and contrast.
8	ON/OFF	<input type="checkbox"/> Switches the instrument power on or off. The instrument automatically turns off 15 minutes after the last key was pressed.
9	HELP	<input type="checkbox"/> Help function with connection diagrams
10	Function selector switch	<input type="checkbox"/> Selects test function.
11	CAL	<input type="checkbox"/> For calibrating the test cables in the R LOW and CONTINUITY function <input type="checkbox"/> Starts the Z _{REF} measurement in the sub-function <input type="checkbox"/> ΔU voltage drop
12	Green LEDs Red LEDs	<input type="checkbox"/> Indicates PASS / FAIL of result.

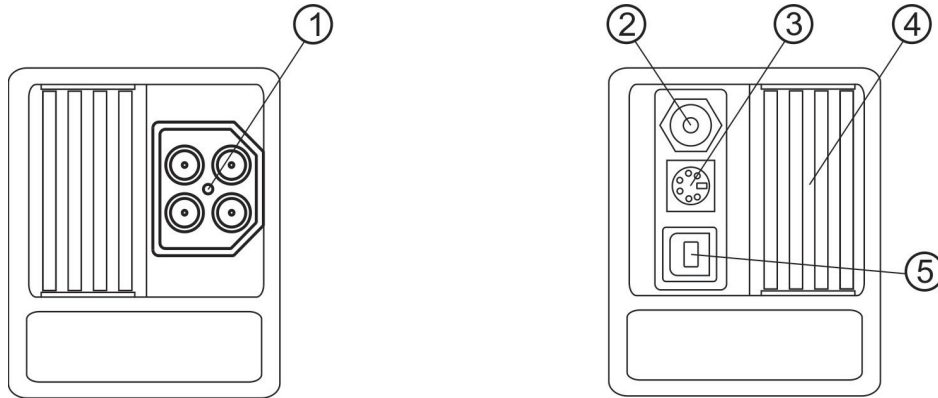

Legend:

1	Test connector	Measuring inputs / outputs.
2	Charger socket	For charging the rechargeable NiMh storage batteries
3	PS/2 connector	Serial RS-232 interface for PC connection
4	Protection cover	
5	USB connector	Without function

1.3 Standard scope of delivery

- ❑ 1 x BENNING IT 115 installation tester
- ❑ 1 x padded carrying case (item no. 10008291)
- ❑ 1 x test cable with shock-proof plug (item no. 10008295)
- ❑ 1 x universal three-wire test cable (black, blue, green) (item no. 10008296)
- ❑ 1 x set of test probes (black, blue, green) (item no. 10008304 - 10008306)
- ❑ 1 x set of alligator clips (black, blue, green) (item no. 10008301 - 10008303)
- ❑ 1 x carrying strap (item no. 10008290)
- ❑ 6 x rechargeable NiMh storage batteries of size AA
- ❑ 1 x charger (item no. 10008308)
- ❑ 1 x printed brief operating manual
- ❑ 1 x calibration certificate



1.4 Indications and meaning of symbols

Terminal voltage monitor

The terminal voltage monitor displays on-line the voltages on the test terminals and information about active test terminals in the AC installation measuring mode.







	The voltage applied is displayed by means of the testing terminal symbol. All three testing terminals L, N and PE are used for the selected measurement.
	The voltage applied is displayed by means of the testing terminal symbol. The testing terminals L and N are used for the selected measurement.
	The testing terminals L and PE are active testing terminals. The testing terminal N should be connected as well in order to have a correct input voltage.
	The polarity of the testing voltage applied (R LOW, R ISO) is displayed at the output terminals L and N.

Battery indication

	Battery capacity indication.
	Low battery. The storage battery charge condition is too low to ensure correct measuring results. Recharge the storage batteries or replace the batteries.
	Charging in progress (if power supply adapter is connected).

Messages

	Measurement is running, consider displayed warnings.
	Conditions on the input terminals allow starting the measurement; consider other displayed warnings and messages.
	Warning! Too high DC voltage (> 50 V DC) applied to the testing terminals!
	Conditions on the input terminals do not allow starting the measurement, consider displayed warnings and messages.
	RCD tripped-out during the measurement (in RCD functions).
	Portable RCD selected (PRCD).
	Instrument is overheated. The measurement is prohibited until the temperature decreases under the allowed limit.
	High electrical noise was detected during measurement. Results may be impaired.
	L and N are changed.
	Warning! High voltage is applied to the test terminals.

	Warning! Dangerous voltage on the PE terminal! Stop the activity immediately and eliminate the fault / connection problem before proceeding with any activity!
	The test cable resistance for the low-impedance measurement / continuity test has not been compensated.
	The test cable resistance for the low-impedance measurement / continuity test has been compensated.
	High resistance to earth of test probes. Results may be impaired.
	Measured signal is out of range (clipped). Results are impaired.
	Fuse F1, F2 or F3 is defective. If one of the fuses F2 or F3 has blown, the device must not be used anymore. In this case, the device must be sent to BENNING for inspection and repair.

Sound warnings

Continuous sound

Warning! Dangerous voltage on the PE terminal is detected.

Evaluation of the measuring result



Measurement result is inside pre-set limits (green LEDs).







Measurement result is out of pre-set limits (red LEDs).

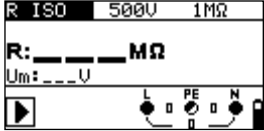

Measurement is aborted. Consider displayed warnings and messages.

1.5 Selecting measuring functions

	Rotary switch for selecting the measuring function	
	Selects sub-function Selects value of parameter / limit	
	Selects parameter / limits	
	Starts measurement	

1.6 Settings

Turn the rotary selector switch to the "SETTINGS" position in order to make the following settings at the tester:

- SELECT LANGUAGE (GB, D, E, F, NL)
- RCD TESTING (according to EN 61008/EN 61009, IEC 60364-4-41, BS 7671, AS/NZS 3017)
- SET ISC FACTOR setting (0.20 - 3.00)
- SELECT COMMANDER (ON/OFF)
- INITIAL SETTINGS

1.7 Batteries and fuses

Batteries

Warning:



- Disconnect all test cables / accessories from the tester and from the installation and switch the tester off before opening the cover of the battery / fuse compartment. Dangerous voltages might occur inside the tester!
- Use alkaline batteries or rechargeable NiMh batteries (storage batteries) of the size AA only! Do not recharge alkaline batteries!
- Please make sure that the batteries / storage batteries are inserted with correct polarity, because otherwise the tester cannot be operated and the batteries / storage batteries will discharge.
- If the tester will not be used for a longer period of time, remove all batteries / storage batteries from the battery compartment in order to protect the tester against leakage of the batteries / storage batteries.

The rechargeable NiMh batteries (storage batteries) will be recharged automatically as soon as the charger is connected to the charging socket. An integrated protective circuit controls the charging process.



Power supply socket polarity

Note:

- Before the first use! Insert the storage batteries into the battery compartment and charge the storage batteries for at least 16 hours.

Fuses

Warning:



- Disconnect all test cables / accessories from the tester and from the installation and switch the tester off before opening the cover of the battery / fuse compartment. Dangerous voltages may be applied to the interior of the tester!
- Three fuses are located behind the rear cover of the installation tester. Only the fuse F1 can be replaced.
If one of the fuses F2 or F3 has blown, the device must not be used anymore. In this case, the device must be sent to BENNING for inspection and repair.
 - F1**
M 0,315 A / 250 V, 20x5 mm
This fuse is intended to protect the internal switching circuits for low-impedance measurement/ continuity test, if during measurement the probe tips are accidentally connected to the mains voltage.

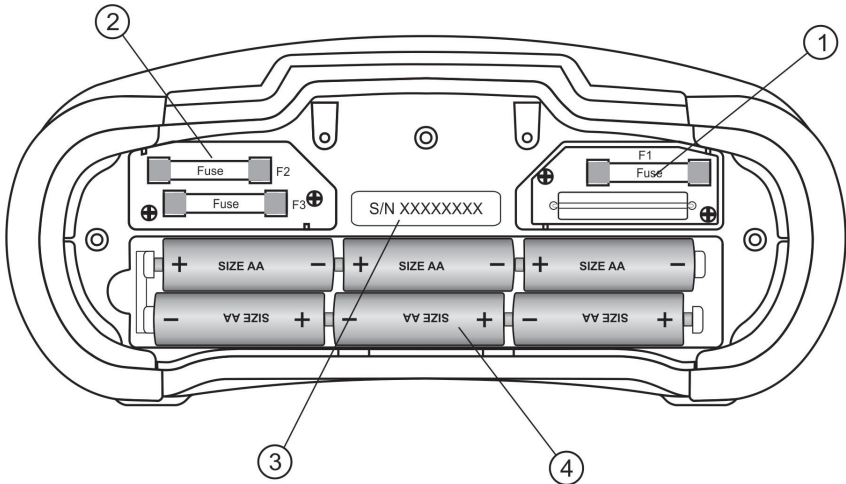

Legend:

1	Fuse F1	M 315 mA / 250 V
2	Fuses F2 and F3	If one of the fuses F2 or F3 has blown, the device must not be used anymore. In this case, the device must be sent to BENNING for inspection and repair.
3	Serial number label	
4	Storage batteries/ batteries	Size AA, rechargeable NiMh / alkaline quantity: 6 pieces

1.8 Calibration

Benning guarantees compliance with this technical and accuracy specifications stated in this operating manual for the first 12 months after the delivery date.

To maintain accuracy of the measuring results, make sure that the device is recalibrated in annual intervals by the BENNING Service (chapter 1.9 Service & support).

As part of the calibration, the device is provided with the latest firmware update and thus always remains up to date.

<http://calibration.benning.de>



1.9 Service & support

Please contact your specialty retailer or the BENNING Service Center for any repair or service work that might be required.

Technical support

Please contact our Technical support for technical questions on handling the device.

Phone: +49 2871 93-555

Fax: +49 2871 93-6555

E-mail: helpdesk@benning.de

Internet: www.benning.de

Returns management

Easily and conveniently use the BENNING returns portal for a quick and smooth returns processing:

<https://www.benning.de/service-de/retourenabwicklung.html>

Phone: +49 2871 93-554

E-mail: returns@benning.de

Return address

BENNING Elektrotechnik und Elektronik GmbH & Co. KG

Retourenmanagement

Robert-Bosch-Str. 20

D - 46397 Bocholt

Additional product information can be found on our website. www.benning.de

1.10 Disposal and environmental protection



At the end of product life, dispose of the unserviceable device and the batteries via appropriate collecting facilities provided in your community.

1.11 Optional accessories

<p>Earthing set Earthing set consisting of 2 earth rods and 3 test cables 2 x L = 20 m, 1 x L = 4.5 m item no.: 044113</p>	
<p>"Commander" test probe "TEST" key for releasing the measuring process, "PASS"/"FAIL" indication by means of green/ red LED, PE contact electrode for detecting the phase voltage at the protective conductor connection PE, key for measuring point and LCD illumination item no. 044155</p>	
<p>"Commander" test plug For shock-proof socket, switchable with "TEST" and "MEM" keys, with "PASS" / "FAIL" indication by means of green/red LED, PE contact electrode for detecting a phase voltage at the protective conductor connection (PE) item no.: 044149</p>	
<p>CEE measuring adapter BENNING TA 6 Measuring adapter for testing 5-pin 16 A CEE sockets. The following measurements are supported: Loop and line impedance, insulation, RCD testing, voltage and phase sequence (rotating field) Item no. 044168</p>	
<p>BENNING TA 7-16, TA 7-32, TA 7-63 CEE measuring adapter for testing 5-pin CEE sockets, universally applicable due to 4 mm safety sockets BENNING TA 7-16, 16 A (044040) BENNING TA 7-32, 32 A (044041) BENNING TA 7-63, 63 A (044042)</p>	
<p>CEE measuring adapter 16 A, 5-pin, for measuring the voltage and phase sequence (rotary field) at 16 A CEE sockets item no.: 044148</p>	
<p>40 m Measurement cable 40 m measurement cable with winder and strap, for the measurement of protective conductors item no.: 044039</p>	

2 Measurements

2.1 Null balance (compensation) of the test cables

1. Set function



Select R LOW Ω or CONTINUITY.

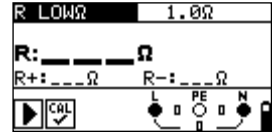

Short-circuit the test cables.

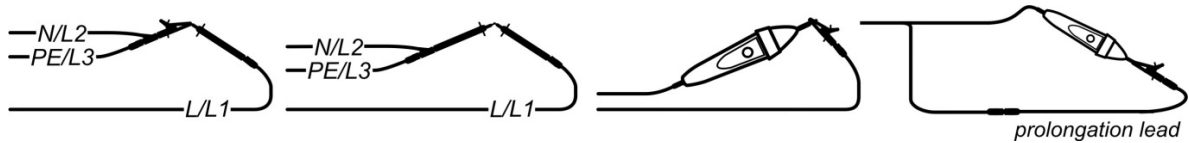

Shorted 3-wire test lead and optional "Commander" test probe (044155)

3. Press the key



4. Press the key CAL.

After performing test leads compensation first measured value and then 0.00 Ω is displayed.

Successful compensation is displayed by means of the  symbol in the "R LOW" and "CONTINUITY" function.

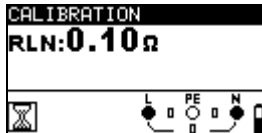

Resistance of the test cable before compensation

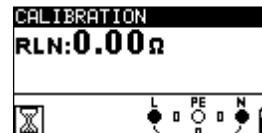

Resistance of the test cables after compensation

2.2 TRMS voltage (V AC/DC), frequency and phase sequence (rotary field)

1. Set function



VOLTAGE TRMS	
U _{ln} : 230V	f: 50.0Hz
U _{lpe} : 230V	
U _{npe} : 0V	
L 230	PE 0
	N 230

2. Connection diagrams

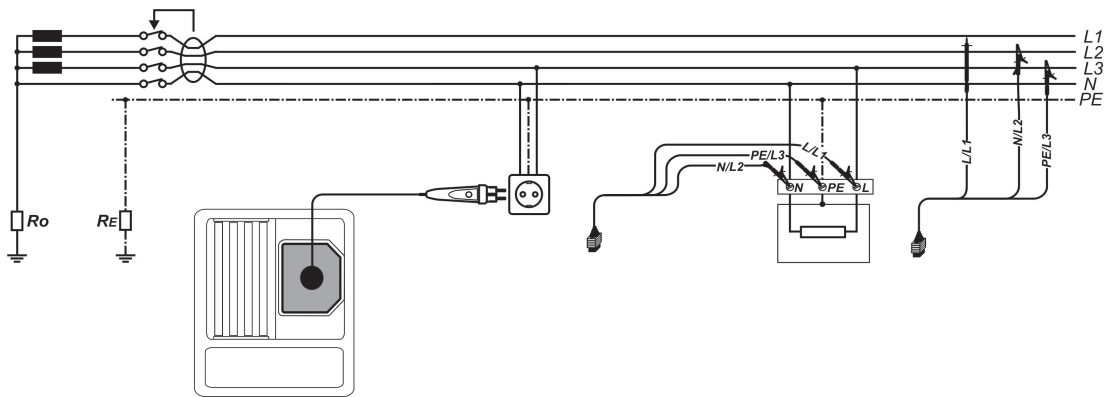

Connection of optional "Commander" test plug (044149) and 3-wire test lead in single-phase system

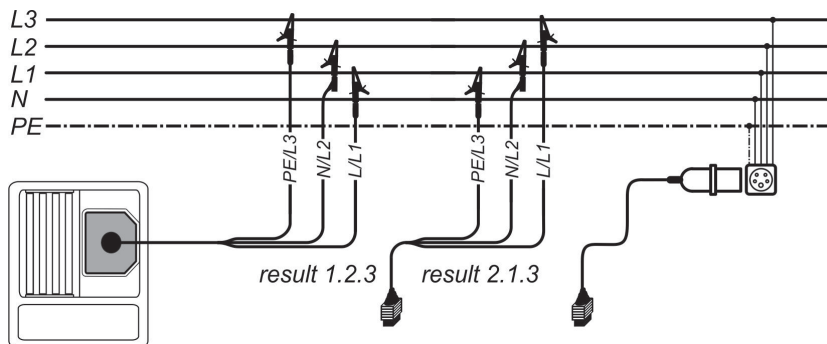

Connection of the three-wire test cable and of the three-phase adapter (optional) (044148) in a three-phase system

3. The measuring result will be shown on the display.

VOLTAGE TRMS	
U _{ln} : 230V	f: 50.0Hz
U _{lpe} : 230V	
U _{npe} : 0V	
L 230	PE 0
	N 230

VOLTAGE TRMS	
U ₁₂ : 412V	f: 50.0Hz
U ₁₃ : 411V	φ: 1.2.3.
U ₂₃ : 410V	
L1 411	L3 410
	L2 412

U_{ln} Voltage between phase (L) and neutral conductors (N)

U_{lpe} ... Voltage between phase (L) and protective conductors (PE)

U_{npe} .. Voltage between neutral (N) and protective conductors (PE)

f Frequency

U₁₂ ... Voltage between phases L1 and L2

U₁₃ ... Voltage between phases L1 and L3

U₂₃ ... Voltage between phases L2 and L3

1.2.3 .. Clockwise phase sequence: OK

3.2.1 .. Counter-clockwise phase sequence: not OK

f Frequency

2.3 Insulation Resistance (R_{ISO})

1. Set function



2. Set parameters and limits.



Test voltage

[50 V, 100 V, 250 V, 500 V, 1000 V]

Minimum limiting value

[without (---), 0.01 MΩ ÷ 200 MΩ]

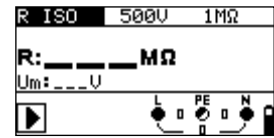

3. Connection diagrams

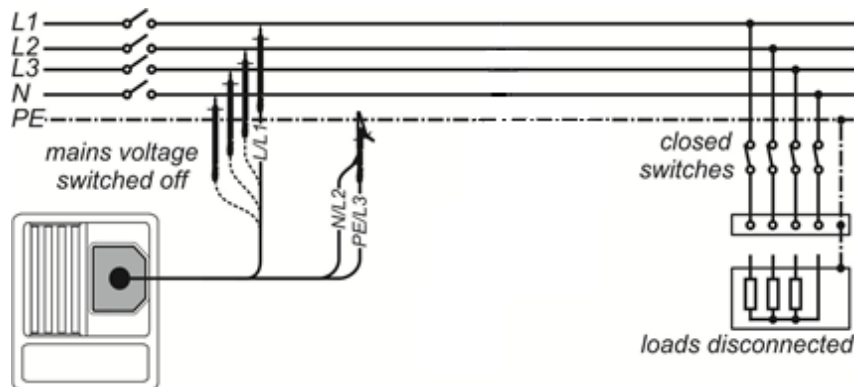

Connection of 3-wire test lead and optional "Commander" test probe (044155)

4. Press and hold the key until result is stabilized.

Double-click  to start continuous measurement.

(„MΩ“ flashes on display). Press the key again to finish the measurement.

5. The measuring result will be shown on the display.

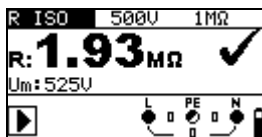

RInsulation resistance

UmTest voltage (actual value)

2.4 Low-impedance resistance (R_{LOW}) / continuity test

1. Set function



2. Set sub-function and limit.



R LOW Ω low-impedance resistance (testing current > 200 mA) or **CONTINUITY** (testing current < 8.5 mA)
Maximum limiting value
 [without (---), 0.1 Ω ÷ 20.0 Ω]
Buzzer [ON/OFF] only for CONTINUITY function

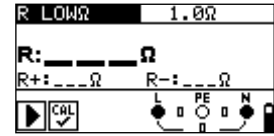

3. Connection diagrams

MPEG....Main Potential Equilizing Collector
 PCC....Protection Conductor Collector

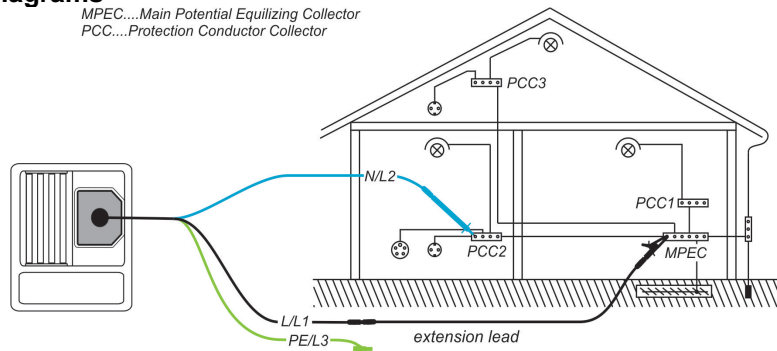

Connection of the three-wire test cable and of the optional measuring line BENNING TA 5 (044039)

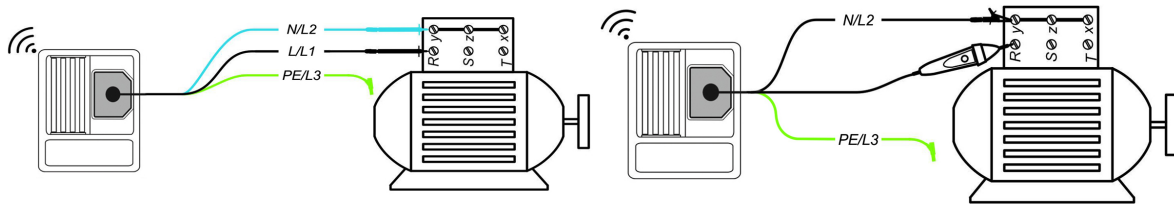

Connection of 3-wire test lead and optional "Commander" test probe (044155)

4.a R LOW Ω low impedance

Press the key



4.b CONTINUITY:

Press the key



Press the key



5. The measuring result will be shown on the display.

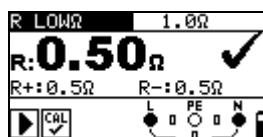

RR LOW Ω
 R+Result at positive polarity
 R-Result at negative polarity

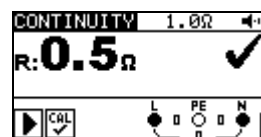

R CONTINUITY resistance

2.6 Loop impedance ($Z_{s\ L-PE}$)

1. Set function



2. Set sub-function, parameters and limits.



Loop impedance:
Zs (for systems without RCD)
Zs rcd (for systems with RCD)
Testing current [Std, Low] (standard, low)
Fuse type [---, NV, gG, B, C, K, D, Z, L, U]
Nominal current of the fuse
Tripping time of the fuse

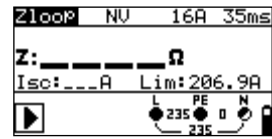

3. Connection diagrams

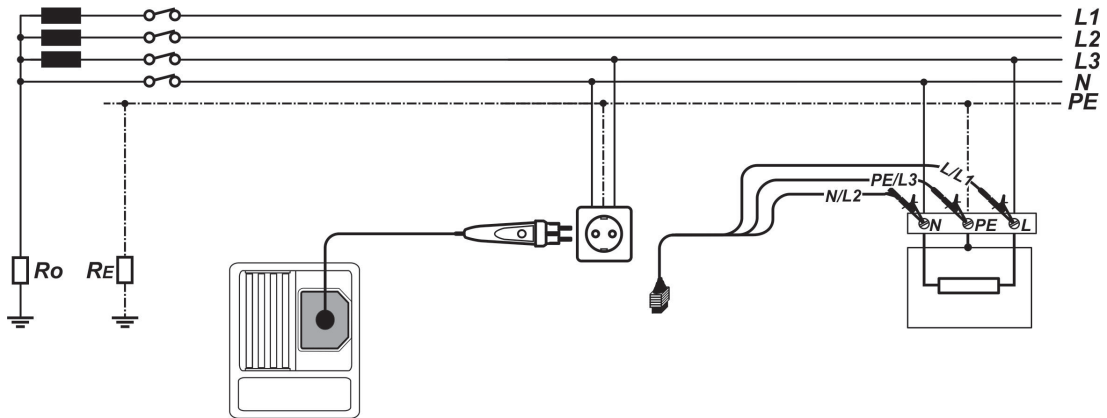

Connecting the optional "Commander" test plug (044149) and the 3-wire test lead

4. Press the key



5. The measuring result will be shown on the display.

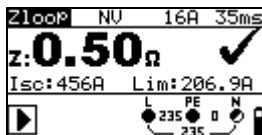

Zs.....Loop impedance (L-PE)

Isc.....prospective short-circuit current (fault current)

Lim ...lower limiting value of the prospective short-circuit current

2.7 Line impedance ($Z_{I\ L-N/L}$)

1. Set function

2. Set sub-function, parameters and limits.

Z Line Line impedance
 ΔU Voltage drop

Fuse type
 [---, NV, gG, B, C, K, D, Z, L, U]
Nominal current of the fuse
Turn-off time of the fuse
Maximum voltage drop [3.0 % ÷ 9.0 %]

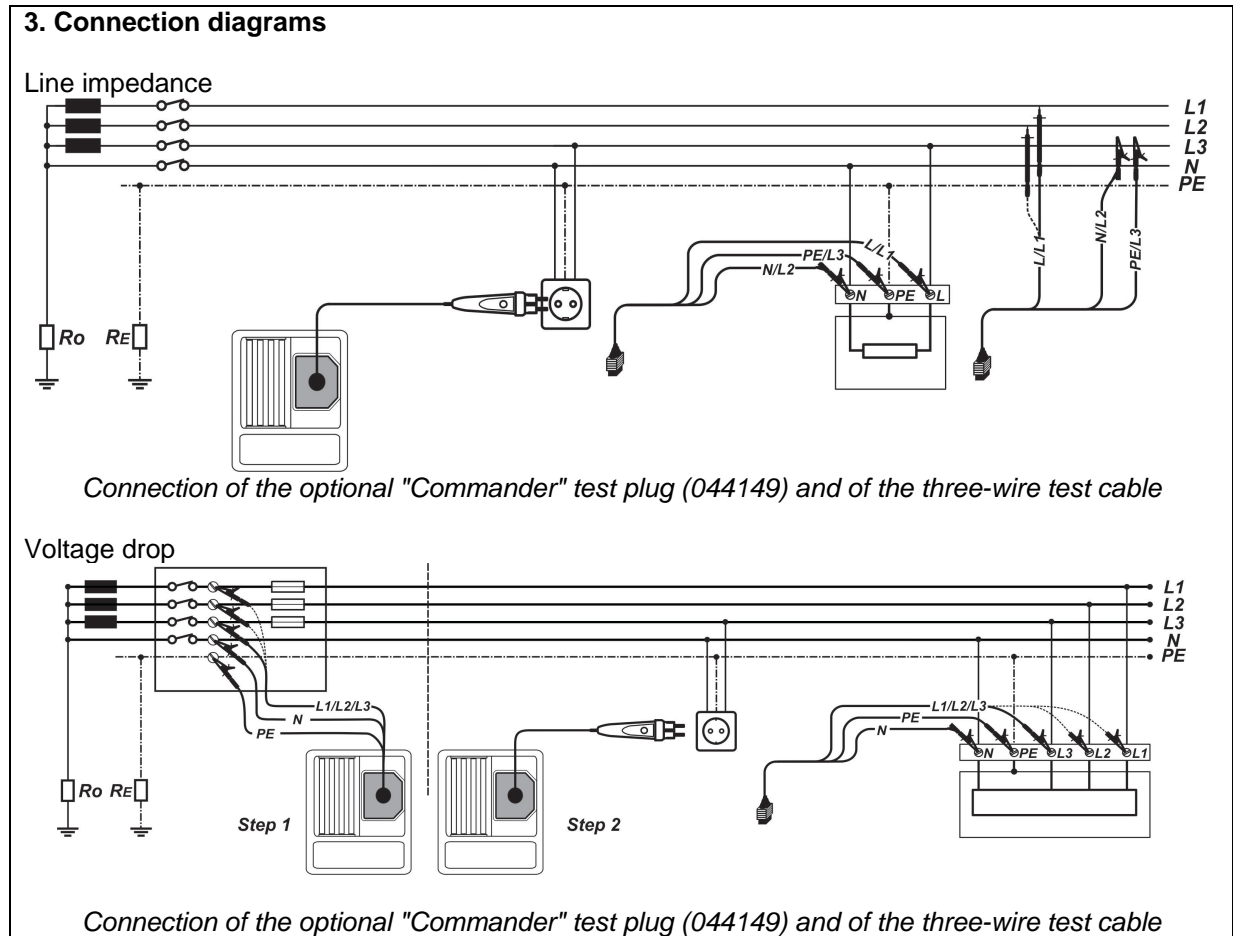

4. Press the key

5. The measuring result will be shown on the display.

Z:Line impedance
Isc.....Prospective short-circuit current
Lim ...Lower limiting value of the prospective short-circuit current

ΔU ... Voltage drop
Isc.... Prospective short-circuit current
Z Line impedance at the measuring point
Zref.. Line impedance of the reference point

2.8 Earth resistance (R_E)

1. Set function



2. Set limits.



EARTH RE Earth resistance
Maximum limiting value
 [without, $1 \Omega \div 5 \text{ k}\Omega$]

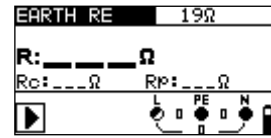

3. Connection diagrams

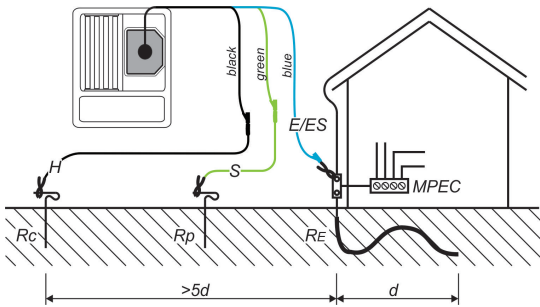

Connection of the optional earthing set
 (044113)

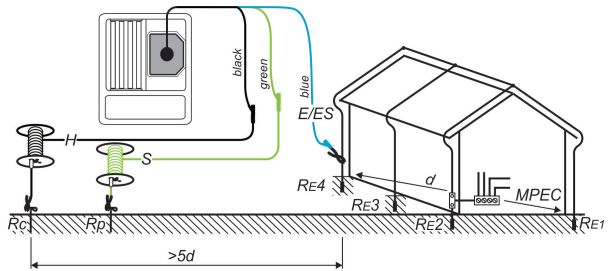

4. Press the key



5. The measuring result will be shown on the display.

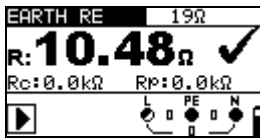

REarth resistance
RpProbe resistance of the S probe (potential)
RcAuxiliary earth electrode resistance of the H probe (current)



BENNING

BENNING Elektrotechnik und Elektronik GmbH & Co. KG

Münsterstraße 135 - 137

D - 46397 Bocholt

Phone: +49 2871 93-0 Fax: +49 2871 93-429

Internet: www.benning.de E-mail: duspol@benning.de