

BENNING

Operating manual

Translation of the German original version



BENNING IT 115 / IT 130

5260 / 04/2023 en

Legal notice

Notes on the quick reference guide

The operating manual and the quick reference guide of the installation tester BENNING IT 115 / IT 130 can be downloaded free of charge in PDF format from the following link:



<http://tms.benning.de/it115>



<http://tms.benning.de/it130>

The installation testers are subject to continuous further development. Benning reserves the right to make changes to the installation tester's design, configuration and technology. The information in this operating manual corresponds to the state of technical knowledge at the time of printing. For this reason, no claims for certain installation tester characteristics can be derived from the contents of this operating manual.

Manufacturer / holder of rights

BENNING Elektrotechnik und Elektronik GmbH & Co. KG
Münsterstraße 135 – 137
46397 Bocholt
Germany
Phone: +49 2871 / 93-0

General non-discrimination

Benning is aware of the importance of language with regard to the gender equality and endeavours to take this into account at all times. To improve readability, we have refrained from consistently using differentiating formulations.

Copyright

All rights reserved.

This document – particularly all of the contents, texts, photographs and graphics that it contains – are protected by copyright.

No part of this documentation or the associated contents may be reproduced or edited, copied or distributed using electronic media in any form (printed, photocopied or using any other method) without express written permission.

Information in this operating manual can be changed at any time without prior notice. Benning is not obligated to make amendments to this operating manual or to keep it up to date. The installation testers are subject to continuous further development. Benning reserves the right to make changes to the installation tester's design, configuration and technology.

TN: 10105456.08

Table of contents

1	Preface	6
2	Safety and operating instructions	7
2.1	Warnings.....	7
2.2	Batteries / storage batteries and charger.....	11
2.3	Standards applied	13
3	Device description	14
3.1	Front panel (IT 115).....	14
3.2	Front panel (IT 130).....	14
3.3	Connection panel (IT 115).....	16
3.4	Connection panel (IT 130).....	17
3.5	Rear panel	18
3.6	Carrying the device	19
3.6.1	<i>Attachment of the carrying strap</i>	20
3.7	Scope of delivery and optional accessories.....	21
3.7.1	<i>Standard scope of delivery</i>	21
3.7.2	<i>Optional accessories</i>	22
4	Operating the device	24
4.1	Indications and acoustic warning signals.....	24
4.1.1	<i>Connection monitor</i>	24
4.1.2	<i>Battery indication</i>	24
4.1.3	<i>Warnings and messages</i>	24
4.1.4	<i>Evaluation field</i>	25
4.1.5	<i>Acoustic warning signals</i>	25
4.1.6	<i>Help menu ("HELP" key)</i>	26
4.1.7	<i>Background lighting and contrast</i>	26
4.2	Function selector switch	27
4.3	"AUTO" mode (IT130)	27
4.4	"SETTINGS" mode (IT 115)	28
4.5	"SETTINGS" mode (IT 130)	28
4.5.1	<i>Memory (IT 130)</i>	29
4.5.2	<i>Language</i>	29
4.5.3	<i>Date and time (IT 130)</i>	29
4.5.4	<i>Earthing system (power supply network)</i>	30
4.5.5	<i>RCD testing</i>	30
4.5.6	<i>Isc factor (scaling factor)</i>	32
4.5.7	<i>Commander ON/OFF</i>	33
4.5.8	<i>Initial settings</i>	33
4.5.9	<i>Clamp settings (IT 130)</i>	34
5	Measurements	36
5.1	TRMS voltage, frequency and phase sequence	36
5.2	Insulating resistance.....	38
5.3	Low-impedance resistance / continuity test	40
5.3.1	<i>Low-impedance resistance with a testing current of 200 mA</i>	40
5.3.2	<i>Continuity test with a testing current of 7 mA</i>	41
5.3.3	<i>Compensation (null balance) of the test cable resistance</i>	42
5.4	RCD testing.....	44
5.4.1	<i>Contact voltage (Uc)</i>	45

5.4.2	Tripping time (RCDt).....	47
5.4.3	Tripping current (RCD I)	47
5.4.4	Automatic test	49
5.5	Loop impedance and prospective short-circuit current.....	51
5.6	Line impedance and prospective short-circuit current / voltage drop	53
5.6.1	Line impedance and prospective short-circuit current.....	54
5.6.2	Voltage drop.....	55
5.7	Earthing resistance	57
5.8	Testing the protective conductor connection (PE)	59
5.9	TRMS current by means of current clamp adapter (IT 130).....	61
5.10	Single-fault leakage current (ISFL) in IT networks (IT 130).....	62
5.11	Luminous intensity (IT 130)	64
6	Management of measured values (IT 130).....	66
6.1	Memory structure (IT 130).....	66
6.2	Saving measuring results (IT 130).....	68
6.3	Recalling measuring results (IT 130).....	69
6.4	Deleting measuring results (IT 130).....	70
6.4.1	Deleting the entire measured value memory (IT 130)	70
6.4.2	Deleting all measurements of each storage location and subordinate storage locations	70
6.4.3	Deleting an individual measurement (IT 130)	71
6.5	Renaming installation structure fields (IT 130).....	72
6.5.1	Renaming installation structure fields by means of the logging software BENNING PC-Win IT 130-200 (IT 130).....	72
6.5.2	Renaming the installation structure fields by means of the barcode scanner (IT 130)	72
6.6	USB and RS232 interface (IT 130).....	73
7	Logging software BENNING PC-Win IT 130-200 (IT 130).....	74
8	Firmware update	74
9	Maintenance	75
9.1	Fuse F1 replacement	75
9.2	Cleaning.....	75
9.3	Calibration.....	76
9.4	Service & support.....	76
9.5	Disposal and environmental protection.....	76
10	Technical data.....	77
10.1	Insulating resistance.....	77
10.2	Low-impedance resistance / continuity test	78
10.2.1	Low-impedance resistance R LOW	78
10.2.2	Continuity test.....	78
10.3	Residual current protection devices (RCDs).....	78
10.3.1	General data (IT 115)	78
10.3.2	General data (IT 130)	79
10.3.3	Contact voltage (Uc).....	80
10.3.4	Tripping time (RCD t).....	80
10.3.5	Tripping current (RCD I) (IT 115).....	81
10.3.6	Tripping current (RCD I) (IT 130).....	81
10.4	Loop impedance and prospective short-circuit current.....	83
10.4.1	Zs function (for systems without RCD).....	83
10.4.2	Zsrcd function (for systems with RCD).....	83
10.5	Line impedance and prospective short-circuit current / voltage drop	84

10.6	Earthing resistance	84
10.7	TRMS voltage, frequency and phase sequence	85
10.7.1	TRMS voltage (AC/DC)	85
10.7.2	Voltage of the connection monitor	85
10.7.3	Frequency	85
10.7.4	Phase sequence (rotary field)	85
10.8	TRMS current (AC / DC) via current clamp adapter (IT 130)	85
10.9	Single-fault leakage current (ISFL) in IT networks (IT 130).....	86
10.10	Luminous intensity (IT 130)	86
10.11	General data	87
Appendix A	Fuse table – Prospective short-circuit current	88
A.1	Fuse, type NV	88
A.2	Fuse, utilization category gG	90
A.3	Line safety switch, tripping characteristic B	92
A.4	Line safety switch, tripping characteristic C	92
A.5	Line safety switch, tripping characteristic K	93
A.6	Line safety switch, tripping characteristic D	93
A.7	Line safety switch, tripping characteristic Z	94
A.8	Line safety switch, tripping characteristic L.....	94
A.9	Line safety switch, tripping characteristic U	95
Appendix B	Standard and optional accessories for specific measuring functions	96
Appendix C	Optional "Commander" test probe, "Commander" test plug	97
C.1	 Safety warnings.....	97
C.2	Batteries	97
C.3	Description of the "Commanders"	98
C.4	LED indications of the "Commanders"	99

1 Preface

The BENNING IT 115 / IT 130 installation device described here (in the following only referred to as "device") is a multifunctional device for testing electrical installations in compliance with IEC 60364-6 (DIN VDE 0100-600) and EN 50110 (DIN VDE 0105-100).

The device is intended for the following measurements and tests:

- TRUE RMS voltage, frequency and rotary field (phase sequence)
- low-impedance resistance, continuity test
- insulating resistance
- residual current protection devices (RCD)
- loop impedance without RCD tripping
- line impedance and voltage drop
- TRUE RMS current by means of optional current clamp adapters (IT 130)
- earthing resistance by means of optional earthing kit
- luminous intensity by means of optional luxmeter (IT 130)
- single-fault leakage current in IT networks (IT 130)

The graphic display with background lighting allows easy reading of measuring results, indications, measuring parameters and messages. Two "PASS" / "FAIL" indications (red / green LEDs) are located next to the LC display.

The device is equipped with all accessories necessary for comfortable testing. It is kept in a padded carrying case together with all accessories.

2 Safety and operating instructions

The following symbols are used both in the operating manual and on the installation device:



Attention! Danger! Please observe the operating manual!



Warning of dangerous voltage!



Protection class II



Earth (voltage to earth)



At the end of product life, dispose of the unserviceable device and the batteries via appropriate collecting facilities provided in your community.



The device complies with EU directives.

2.1 Warnings

In order to ensure a high degree of operational safety during the tests and measurements and to avoid damaging of the device, the general warnings listed in the following must be adhered to.



Warnings – general information:

- ❑ In case the installation device is not used according to this operating manual, the protection provided by the device might be impaired!
- ❑ Please read this operating manual carefully, because otherwise the use of the device might involve dangers for the user, the device or the test object!
- ❑ Never use the device or the corresponding accessories, if they exhibit visible damages!
- ❑ Absolutely observe all general safety instructions in order to avoid the risk of an electric shock when handling dangerous voltages!
- ❑ If the fuse F1 has blown, please follow the instructions of this operating manual to replace it! Only use a fuse complying with the specification (see chapter 7.1) as replacement.
If one of the fuses F2 or F3 has blown, the device must not be used anymore. In this case, the device must be sent to BENNING for inspection and repair.
- ❑ Never use the device in AC supply systems with voltages higher than 550 V AC.
- ❑ Any service, repair or adjustments of the device and of the corresponding accessories must be carried out by authorized qualified personnel only!
- ❑ Please use standard or optional BENNING accessories only which are available from your authorized specialty retailer!
- ❑ Please observe that the measuring category of some accessories might be lower than that of the device. Test probes and "Commander" test probes are provided with detachable protective caps. If these attachable protective caps are removed, the

measuring category will be reduced to CAT II. Please check the markings of the accessories!

without attachable protective cap, 18 mm tip:

CAT II 1000 V to earth

with attachable protective cap, 4 mm tip:

CAT II 1000 V / CAT III 600 V /

CAT IV 300 V to earth

- ❑ The device comes with rechargeable NiMh storage batteries. The storage batteries must be replaced only as shown on the label at the battery compartment cover or as described in this operating manual and must be replaced with storage batteries of the same type only. Do not use standard alkaline batteries while the charger is connected, because otherwise these batteries might explode!
- ❑ Dangerous voltages are applied to the interior of the device! Disconnect all test cables, disconnect the charger and switch off the device before opening the cover of the battery / fuse compartment.
- ❑ Do not connect any voltage source to the C1 input. This input must be used for connection of the current clamp adapters only. The maximum input voltage is 3 V!
- ❑ Absolutely observe all common safety instructions in order to avoid the risk of an electric shock when working on electrical installations!



Warnings with regard to measurements:

Insulating resistance

- ❑ Measurements of the insulating resistance must be carried out only at test objects which are free of voltage!
- ❑ Never touch the test object during measurement before it is completely discharged! Danger of life-threatening electric shocks!
- ❑ If the insulating resistance is measured on capacitive test objects, discharging might take place time-delayed! During discharge, the warning  as well as the current voltage (Udisch) are displayed until the voltage falls below 30 V.
- ❑ Do not connect any measuring input to an external voltage higher than 550 V (AC or DC) in order not to damage the device!

Low-impedance measurement / continuity test

- ❑ Low-impedance measurements / continuity tests must be carried out on discharged test objects only!
- ❑ The test result might be influenced by parallel impedances.

Testing the PE connection

- ❑ If a phase voltage is detected at the PE connection, immediately stop all measurements. Make sure that the error in the installation is eliminated before going on with the measurements!

Remarks with regard to measurements:**General**

- ❑ The  icon means that the selected measurement cannot be carried out due to irregular conditions at the input terminals.
- ❑ Carry out measurements of the insulating resistance, low-impedance resistance, continuity and earthing resistance on discharged objects only!
- ❑ The "PASS" / "FAIL" indication is activated, if a limiting value has been defined. Choose appropriate limiting values for evaluating the measuring results.
- ❑ If only two of the three test cables are connected to the electrical installation to be tested, only the voltage value between those two test cables shall be valid.

Insulating resistance

- ❑ The three-wire test cable as well as the "Commander" test probe can be used for measuring the insulating resistance.
- ❑ If a voltage higher than 30 V (AC or DC) is measured at the testing terminals, the measurement of the insulating resistance cannot be carried out.
- ❑ The device automatically discharges test objects after the measurement is finished.
- ❑ Double-click the "TEST" key to carry out a continuous measurement.

Low-impedance measurement / continuity test

- ❑ If a voltage higher than 10 V (AC or DC) is measured at the testing terminals, the low-impedance measurement / continuity test cannot be carried out.
- ❑ Before carrying out a low-impedance measurement / continuity test, compensate the test cable resistance (if necessary).

Earthing resistance

- ❑ If a voltage higher than 30 V (AC or DC) is measured at the testing terminals, the measurement of the earthing resistance cannot be carried out.
- ❑ If an interference voltage higher than 5 V is detected at the testing terminals H and E or S, the warning symbol "⚡" will be displayed indicating that the measuring result might have been influenced!

Residual current protection devices (RCDs)

- ❑ The parameters set for a measuring function will be taken over for other RCD measurements as well!
- ❑ Contact voltage measurement usually does not involve any tripping of the residual current protection devices (RCD). However, the tripping threshold might be exceeded due to leakage currents via the protective conductor (PE) or via capacitive connections between the conductors L and PE.
- ❑ Compared to the loop impedance R_L (contact voltage subresult), the measurement of the loop impedance Z_{Srcd} needs more time, but offers a considerably higher degree of accuracy.
- ❑ The tripping time and tripping current measurement is only carried out, if the contact voltage at nominal differential current is lower than the preset limiting value of the contact voltage.
- ❑ The automatic test sequence (RCD AUTO function) is stopped, if the tripping time is outside the admissible value.

Loop impedance

- ❑ The lower limiting value of the prospective short-circuit current depends on the fuse type, on the fuse current rating and tripping time as well as on the I_{sc} scaling factor.
- ❑ The stated accuracy of the parameters tested shall only apply, if the mains voltage is stable during measurement.
- ❑ Loop impedance measurements (Z_s) involve tripping of residual current protection devices (RCDs).
- ❑ Loop impedance measurements (Z_{sRcd}) normally do not involve tripping of the residual current protection device (RCD). However, the tripping threshold might be exceeded due to leakage currents flowing to the protective conductor (PE) or via the capacitive connection between the conductors L and PE.

Line impedance / voltage drop

- ❑ During phase-to-phase measurements of the line impedance $Z_i(L-L)$ with the test cables PE and N being connected, a warning of dangerous PE voltages is displayed. However, the measurement will be carried out.
- ❑ The stated accuracy of the parameters tested shall only apply, if the mains voltage is stable during measurement.
- ❑ Depending on the connection voltage detected, the test terminals L and N are inverted automatically.

Luminous intensity (IT 130)

- ❑ Shadows and irregular exposure to light might influence the measuring result!
- ❑ Artificial light sources reach their full capacity (see Technical Data of the light sources) only after a certain time and therefore should be switched on until they reach this capacity before carrying out measurements.

Testing the protective conductor connection (PE)

- ❑ The PE connection can be tested only in switch positions "FI/RCD", " $Z_s(L-PE)$ " and " $Z_i(L-N/L)$ "!
- ❑ For correct measurement of the PE connection, the "TEST" key must be touched for several seconds.
- ❑ Make sure not to stand on an insulated floor, because otherwise the test result might be incorrect!

2.2 Batteries / storage batteries and charger

The device can be operated with six alkaline batteries (type AA) or with rechargeable NiMh batteries (storage batteries). The specified operating time refers to storage batteries with a nominal capacity of 2100 mAh. The batteries' state of charge is permanently displayed in the lower right part of the LC display. If the battery voltage is too low, this will be displayed as shown in figure 2.1. This indication is shown several seconds before the device switches off.

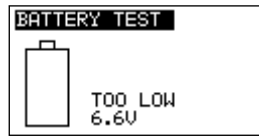

Figure 2.1: Indication of discharged batteries

The rechargeable NiMh storage batteries will be charged automatically as soon as the charger is connected with the charging jack of the device. The polarity of the charging jack will be displayed as shown in figure 2.2. An integrated protective circuit controls the charging process and ensures an optimum battery lifetime.



Figure 2.2: Polarity of the charging jack

Symbol:



Indication of the storage battery charging process

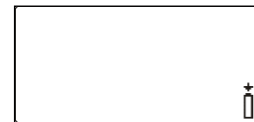

Figure 2.3: Charging in progress



General warnings:

- ❑ If the device is connected to an installation, a dangerous voltage might be applied to the battery compartment! Disconnect all test cables / accessories from the device and switch the device off before replacing the batteries / storage batteries and before opening the cover of the battery / fuse compartment!
- ❑ Please make sure that the batteries / storage batteries are inserted correctly, because otherwise the device cannot be operated and the storage batteries will discharge.
- ❑ Do not recharge alkaline batteries!
- ❑ Use only the charger included in the delivery!

Notes:

- ❑ Before the first use! Insert the storage batteries into the battery compartment and charge the storage batteries for at least 16 hours.
- ❑ The charger inside the device is a cell pack charger. This means that the storage batteries are connected in series during charging. For this reason, the storage batteries must be equivalent (same state of charge, same condition, same type and same age).
- ❑ If the device is not used for a longer period of time, remove all storage batteries from the battery compartment.
- ❑ Use alkaline batteries or rechargeable NiMh batteries of size AA only! It is recommended to use storage batteries with a minimum capacity of 2100 mAh.
- ❑ Unpredictable chemical processes might occur during the charging of storage batteries that have not been used for a longer period of time (more than 6 months). In this case, it is recommended to repeat the charging / discharging cycle at least 2 to 4 times.

- ❑ If no improvement is achieved after several charging / discharging cycles, every storage battery should be tested individually (by comparing the storage battery voltages, testing by means of a cell charger etc.). It is very likely that only some of the storage batteries have lost capacity. If one storage battery differs from the other ones, this might affect the correct functioning of the entire storage battery block!
- ❑ The effects described above must not be confused with the normal battery capacity decrease over time. All rechargeable batteries (storage batteries) lose some of their battery capacity when being charged / discharged several times. This information is provided in the technical data specified by the battery manufacturer.

2.3 Standards applied

The device is manufactured and tested in compliance with the following regulations:

Electromagnetic compatibility (EMC)	
EN 61326-1	Electrical equipment for measurement, control and laboratory use – EMC requirements Class B (hand-held equipment in controlled EM environments)
Safety (LVD)	
EN 61010-1	Safety requirements for electrical equipment for measurement, control and laboratory use – Part 1: General requirements
EN 61010-2-030	Safety requirements for electrical equipment for measurement, control and laboratory use – Part 2-030: Particular requirements for testing and measuring circuits
EN 61010-031	Safety requirements for electrical equipment for measurement, control and laboratory use – Part 031: Safety requirements for hand-held probe assemblies for electrical measurement and test
EN 61010-2-032	Safety requirements for electrical equipment for measurement, control and laboratory use – Part 2-032: Particular requirements for hand-held and hand-manipulated current sensors for electrical test and measurement
Functionality	
EN 61557	Electrical safety in low-voltage distribution systems up to 1000 V _{AC} and 1500 V _{DC} – Equipment for testing, measuring or monitoring of protective measures Part 1: General requirements Part 2: Insulation resistance Part 3: Loop impedance Part 4: Resistance of earth connection and equipotential bonding Part 5: Resistance to earth Part 6: Effectiveness of residual current devices (RCD) in TT, TN and IT systems Part 7: Phase sequence Part 10: Combined measuring equipment for testing, measuring or monitoring of protective measures
DIN 5032	Photometry Part 7: Classification of illuminance meters and luminance meters
Reference standards for electrical installations and components	
EN 61008	Residual current operated circuit-breakers without integral overcurrent protection for household and similar uses (RCCBs)
EN 61009	Residual current operated circuit-breakers with integral overcurrent protection for household and similar uses (RCBOs)
EN 60364-4-41	Low-voltage electrical installations – Part 4-41: Protection for safety – Protection against electric shock
IEC 62955	Residual direct current detecting device (RDC-DD) to be used for mode 3 charging of electric vehicles
BS 7671	IEE Wiring Regulations (17 th edition)
AS / NZS 3017	Electrical installations – Verification guidelines

Note on EN and IEC standards:

- This operating manual contains references to European standards. All standards of the series EN 6XXXX (e.g. EN 61010) correspond to the respective IEC standards with the same number (e.g. IEC 61010). They only differ in the modified parts due to the European harmonization procedures.

3 Device description

3.1 Front panel (IT 115)

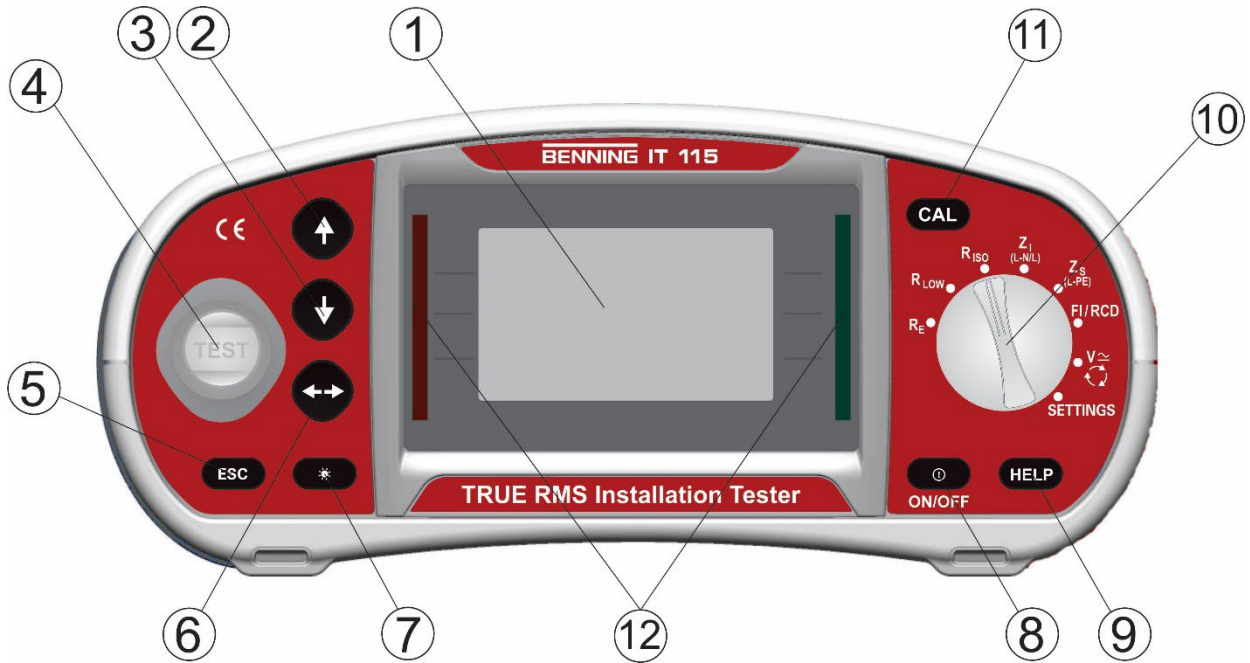

Figure 3.1: Front panel IT 115

3.2 Front panel (IT 130)

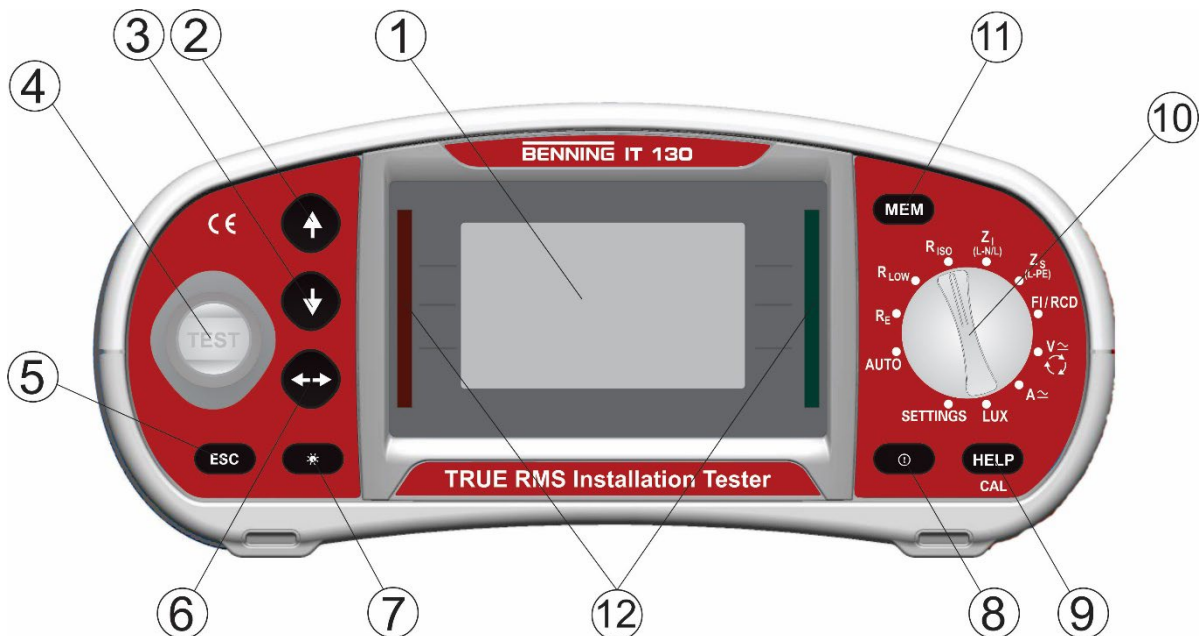

Figure 3.2: Front panel IT 130

Caption:

1	LCD	Matrix display with 128 x 64 pixels and background lighting
2	UP	Modifies selected parameters
3	DOWN	
4	TEST	Start of measurement PE contact electrode for protective conductor connection
5	ESC	Back / cancel
6	TAB	Selects parameters in the measuring function selected
7	Backlight, Contrast	Modifies background lighting and contrast
8	ON / OFF	Switches the device on or off; automatic switch-off ("APO") after 15 minutes without pressing a key
9	HELP (IT 115)	Help function with connection diagrams
	HELP / CAL (IT 130)	Help function with connection diagrams (press approx. 2 seconds for R LOW and ΔU) For calibrating the test cables in the R LOW and CONTINUITY function Starts the Z_{REF} measurement in the sub-function ΔU voltage drop
10	Function selector switch	Rotary switch for selecting the measuring functions, "AUTO" switch position and "SETTINGS" mode
11	CAL (IT 115)	For calibrating the test cables in the R LOW and CONTINUITY function Starts the Z_{REF} measurement in the sub-function ΔU voltage drop
	MEM (IT 130)	Storage / recall of measuring results; stores the settings of the current clamp adapter
12	Green / red LED	PASS / FAIL indication of the measuring results

3.3 Connection panel (IT 115)

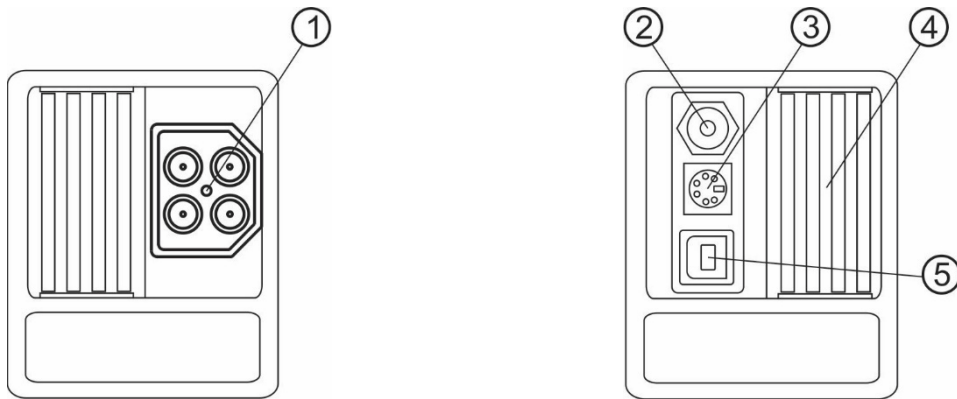

Figure 3.3: Connection panel (IT 115)

Caption:

1	Test connection	Measuring inputs / outputs
2	Charging jack	For charging rechargeable NiMh storage batteries
3	PS/2 port	Serial RS232 interface for service
4	Protective cover	
5	USB port	Without function!



Warnings!

- ❑ The maximum admissible voltage between the testing terminals and earth is 550 V!
- ❑ The maximum admissible voltage between the testing terminals is 550 V!
- ❑ The maximum admissible short-term voltage of the external charger is 14 V!

3.4 Connection panel (IT 130)

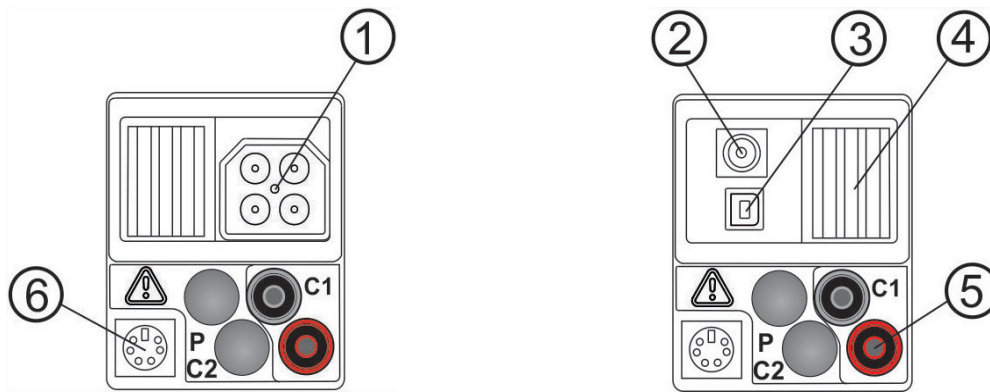

Figure 3.4: Connection panel (IT 130)

Caption:

1	Test connection	Measuring inputs / outputs
2	Charging jack	For charging rechargeable NiMh storage batteries
3	USB port	USB interface (1.1) for PC connection
4	Protective cover	
5	C1	Measuring input for optional current clamp adapter BENNING CC 1 / BENNING CC 3
6	PS/2 port	Serial RS232 interface for PC connection; connection for optional BENNING luxmeter type B (044111) and barcode scanner (009371)



Warnings!

- ❑ The maximum admissible voltage between the testing terminals and earth is 550 V!
- ❑ The maximum admissible voltage between the testing terminals is 550 V!
- ❑ The maximum admissible voltage at the measuring input C1 is 3 V!
- ❑ The maximum admissible short-term voltage of the external charger is 14 V!

3.5 Rear panel

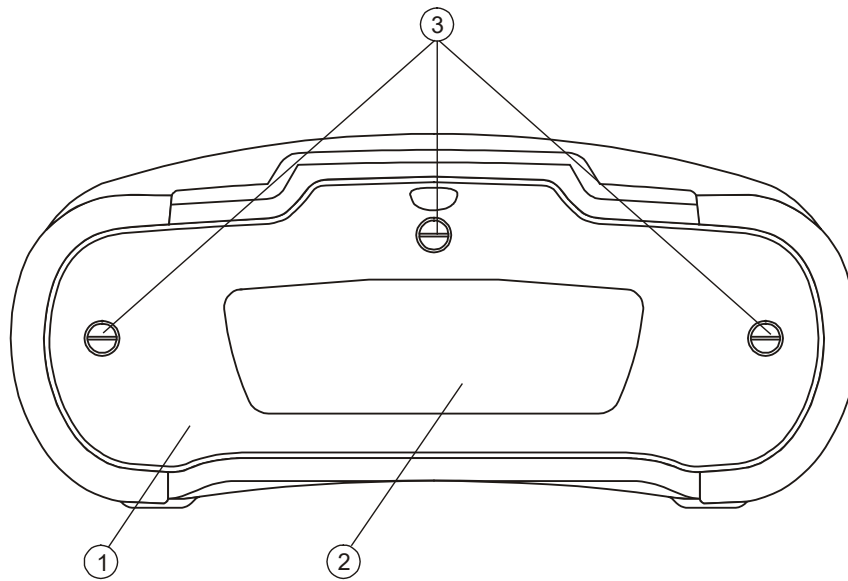

Figure 3.5: Rear panel

Caption:

1	Cover of the battery / fuse compartment
2	Information label
3	Screws for the battery / fuse compartment cover

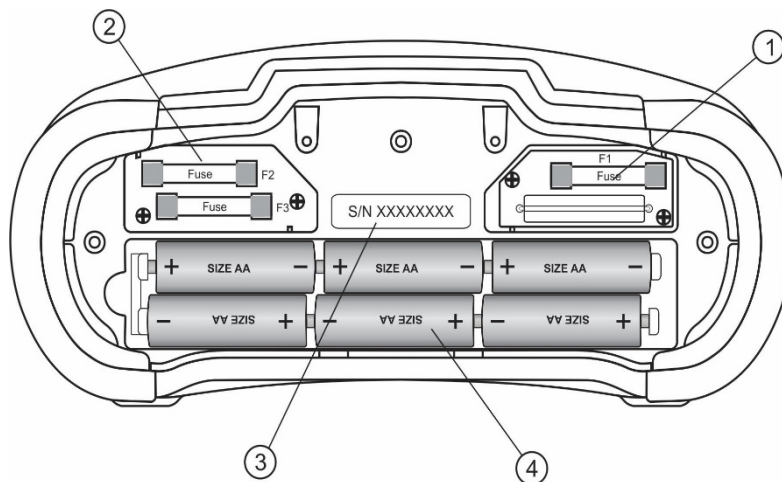

Figure 3.6: Battery / fuse compartment

Caption:

1	Fuse F1	M 315 mA / 250 V
2	Fuses F2 and F3	If one of the fuses F2 or F3 has blown, the device must not be used anymore. In this case, the device must be sent to BENNING for inspection and repair.
3	Serial number label	
4	Storage batteries / batteries	Size AA, alkaline / rechargeable NiMh, quantity: 6 pieces

3.6.1 Attachment of the carrying strap

Please choose one of the two methods shown:

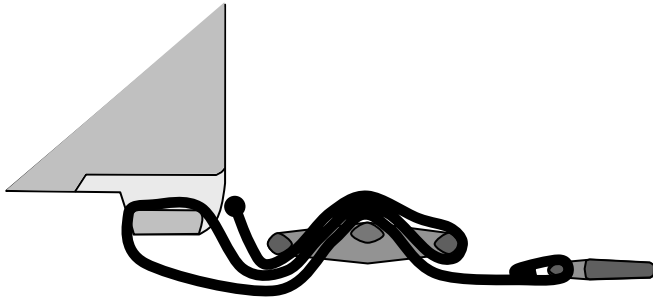

Figure 3.6: First method

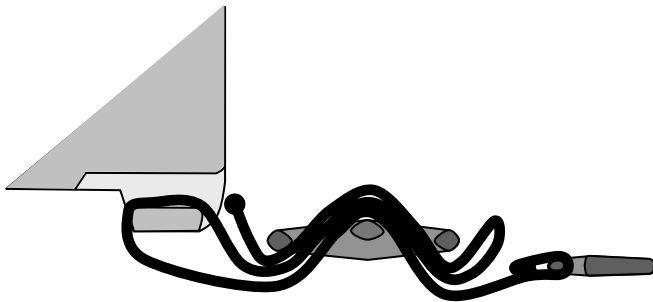

Figure 3.7: Alternative method

Please check the carrying strap for safe fastening regularly.

3.7 Scope of delivery and optional accessories

3.7.1 Standard scope of delivery

- 1 x BENNING IT 115 / IT 130
 - 1 x padded carrying case (item no. 10008291)
 - 1 x test cable with shock-proof plug (item no. 10008295)
 - 1 x universal three-wire test cable (black, blue, green) (item no. 10008296)
 - 1 x set of test probes (black, blue, green) (item no. 10008304 - 10008306)
 - 1 x set of alligator clips (black, blue, green) (item no. 10008301 - 10008303)
 - 1 x carrying strap (item no. 10008290)
 - 6 x rechargeable NiMh storage batteries of size AA
 - 2 x batteries of size AAA
 - 1 x charger (item no. 10008308)
 - 1 x quick reference guide
 - 1 x calibration certificate
-
- 1 x "Commander" test probe (item no. 044155) (IT 130)
 - 1 x RS 232-PS/2 interface cable (item no. 10008313) (IT 130)
 - 1 x USB interface cable (item no. 10008312) (IT 130)



Scope of delivery BENNING IT 115









Scope of delivery BENNING IT 130

The logging software BENNING PC-Win IT 130-200 and the operating manual (PDF file) can be found on the product website of the DEVICE for free download.

<http://tms.benning.de/it130>

3.7.2 Optional accessories

<p>Earthing kit Earthing kit, 2 earth rods, 3 test cables, 2 x L = 20 m, 1 x L = 4.5 m Item no.: 044113</p>	
<p>Current clamp adapters (IT 130) BENNING CC 1, 1 A to 400 A AC Output: 1 mV per 1 A Item no.: 044037 BENNING CC 3, 0.2 A to 300 A AC / DC Output: 1 mV / 10 mV per 1 A Item no.: 044038</p>	
<p>Luminous intensity sensor (IT 130) BENNING Luxmeter type B For the planning and installation of interior and exterior lighting. Item no.: 044111</p>	
<p>"Commander" test probe (IT 115) "TEST" key for releasing the measuring process, "PASS"/"FAIL" indication by means of green/ red LED, PE contact electrode for detecting the phase voltage at the protective conductor connection PE, key for measuring point and LCD illumination Item no. 044155</p>	
<p>"Commander" test plug For shock-proof socket, switchable with "TEST" and "MEM" keys, with "PASS" / "FAIL" indication by means of green/red LED, PE contact electrode for detecting the phase voltage at the protective conductor connection (PE). Item no.: 044149</p>	
<p>CEE measuring adapter BENNING TA 6 Measuring adapter for testing 5-pin 16 A CEE sockets. The following measurements are supported: Loop and line impedance, insulation, RCD testing, voltage and phase sequence (rotating field) Item no.: 044168</p>	

BENNING TA 7-16, TA 7-32, TA 7-63

CEE measuring adapter for testing 5-pin CEE sockets, universally applicable due to 4 mm safety sockets

BENNING TA 7-16, 16 A (044040)

BENNING TA 7-32, 32 A (044041)

BENNING TA 7-63, 63 A (044042)

**CEE measuring adapter**

16 A, 5-pin, for measuring the voltage and phase sequence (rotary field) at 16 A CEE sockets.

Item no.: 044148

**Measuring line (40 m)**

40 m measuring line with rewriter and wrist strap, for measuring protective conductor connections.

Item no.: 044039

**Barcode scanner**

Barcode scanner with PS/2 interface for identifying the measuring point and renaming the storage location.

Item no.: 009371



4 Operating the device

4.1 Indications and acoustic warning signals

4.1.1 Connection monitor

The connection monitor shows the voltages applied to the testing terminals as well as information on active testing terminals in the AC mains.

	The voltage applied is displayed together with the testing terminal indication. All three testing terminals L, N and PE are used for the selected measurement.
	The voltage applied is displayed together with the testing terminal indication. The testing terminals L and N are used for the selected measurement.
	The testing terminals L and PE are active testing terminals. The testing terminal N should be connected as well to show a correct input voltage.
	The polarity of the testing voltage applied (R LOW, R ISO) is displayed at the output terminals L and N.

4.1.2 Battery indication













The battery indication shows the current state of charge of the storage battery as well as whether an external charger is connected.

	Battery capacity indication
	Low state of charge. The storage battery's state of charge is too low to ensure correct measuring results. Replace the batteries or recharge the storage batteries.
	Charging in progress (with the charger being connected)



4.1.3 Warnings and messages

The following warnings and messages are displayed:

	Warning! High voltage is applied to the testing terminals.
	Warning! Dangerous voltage at the PE connection! Immediately stop the measuring process and eliminate the fault / the connection problem before continuing with the measurement!
DC VOLTAGE!	Warning! Too high DC voltage (> 50 V DC) applied to the testing terminals!
	The conditions at the input terminals allow starting the measurement. Please observe further warnings and messages!
	The conditions at the input terminals do not allow starting the measurement. Please observe further warnings and messages!
	Measurement is in progress. Please observe warnings that might be displayed!
	The device is overheated. Measurements are interrupted until the internal temperature has dropped below the admissible limiting value.

	Results can be saved.
	A high interference voltage has been detected during measurement. This might result in incorrect measuring results.
	L and N have been interchanged.
	RCD has been tripped during measurement (in RCD functions).
	Portable RCD (PRCD) has been selected (only for documentation purposes).
	RCD of type EV (Electric Vehicle) (IT 130)
	RCD of type MI (Mobile Installation) (IT 130)
	The test cable resistance for low-impedance measurement / continuity test has been compensated.
	High earthing resistance of the measuring probes. This might result in incorrect measuring results.
	The current is too low for the accuracy specified. This might result in incorrect measuring results. Please check in the current clamp adapter settings whether the sensitivity of the current clamp adapter can be increased.
	The measuring signal is outside the measuring range This might result in incorrect measuring results.
	Single fault in the IT network.(IT 130)
	Fuse F1, F2 or F3 is defective. If one of the fuses F2 or F3 has blown, the device must not be used anymore. In this case, the device must be sent to BENNING for inspection and repair.

4.1.4 Evaluation field

	The measuring result is within the preset limiting values (green LED).
	The measuring result is outside the preset limiting values (red LED).
	Measurement has been aborted. Please observe the warnings and messages displayed.

4.1.5 Acoustic warning signals

Continuous sound	Warning! Dangerous voltage at the PE connection!
------------------	---

4.1.6 Help menu ("HELP" key)

HELP	Opens the help menu.
-------------	----------------------

Help menus are available for all measuring functions. The help menu contains graphic connection diagrams showing how to connect the device to the electrical installation. After having selected the desired measuring function, press the "HELP" key to view the corresponding help menu.

Keys used in the help menu

UP / DOWN	Selects the next / previous connection diagram
ESC / HELP / function selector switch	Use these keys to exit the help menu.

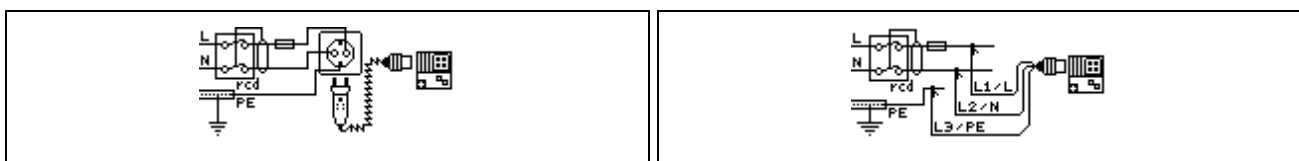

Figure 4.1: Connection diagrams of the help menu

4.1.7 Background lighting and contrast

Use the key for background lighting and contrast to make the following settings:

Briefly press the key	Activates the background lighting for approx. 10 seconds
Press and hold the key for 1 second	Switches the background lighting on permanently until the device switches off or the key is pressed again
Press and hold the key for 2 seconds	Allows to set the LCD contrast

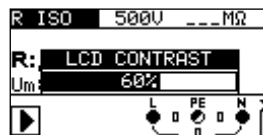

Figure 4.2: LCD contrast setting

Keys used for contrast setting

UP	Increases the contrast
DOWN	Reduces the contrast
TEST	Applies the adjusted contrast
ESC	Exits the settings without any changes

4.2 Function selector switch

The function selector switch is intended for selecting the

- ❑ test and measuring functions
- ❑ "AUTO" mode (IT 130)
- ❑ "SETTINGS" mode

Key functions after having selected the **test / measuring function**:

UP / DOWN	Selects the sub-function of the adjusted test / measuring function (only for rotary switch positions R_{LOW} , Z_I , Z_S , FI/RCD)
TAB	Selects the parameters and limiting values
TEST	Start of measurement
MEM (IT 130)	Storage / recall of the measuring results
ESC	Back / cancel

Key functions in the **Parameters** field:

UP / DOWN	Modifies the selected parameter
TAB	Selects the next parameter
MEM (IT 130)	Storage / recall of the measuring results

Parameters and limiting values for evaluating the measuring results:

Parameter, limiting value	WITHOUT	No parameters / limiting values, indication: ____.
	ON	Measuring results – will be marked as "PASS" / "FAIL" according to the parameters and limiting values set

Please find further information on how to use the test / measuring functions of the device in chapter **5. Measurements**.

4.3 "AUTO" mode (IT130)

Turn the function selector switch to the "**AUTO**" mode to select the test / measuring functions carried out by means of the "Commander" test probe or the optional "Commander" test plug for shock-proof sockets (044149).

Select the test / measuring function by means of the  keys of the "Commander".

Please find a detailed description of the "Commander" test probe and the optional "Commander" test plug for shock-proof sockets (044149) in Appendix C.

4.4 "SETTINGS" mode (IT 115)

Turn the measuring function selector switch to the **"SETTINGS"** mode in order to make the following settings at the tester:

- ❑ **SELECT LANGUAGE** (GB, D, E, F, NL)
- ❑ **RCD TESTING** (according to EN 61008 / EN 61009, IEC 60364-4-41, BS 7671, AS/NZS 3017)
- ❑ **SET I_{sc} FACTOR** (0.20 - 3.00)
- ❑ **COMMANDER ON/OFF**
- ❑ **INITIAL SETTINGS** (reset to factory settings)

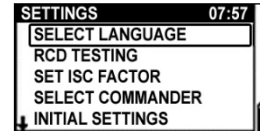

Figure 4.3:
"SETTINGS" mode

Keys used:

UP / DOWN	Selects the respective option
TEST	Confirms the selected option
ESC / function selector switch	Back / cancel without any changes

4.5 "SETTINGS" mode (IT 130)

Turn the measuring function selector switch to the **"SETTINGS"** mode in order to make the following settings at the device:

- ❑ **MEMORY** (recall data, delete data, delete entire memory)
- ❑ **SELECT LANGUAGE** (GB, D, E, F, NL)
- ❑ **SET DATE / TIME**
- ❑ **EARTHING SYSTEM** (TN/TT or IT network)
- ❑ **RCD TESTING** (according to EN 61008 / EN 61009, IEC 60364-4-41, BS 7671, AS/NZS 3017)
- ❑ **SET I_{sc} FACTOR** (0.20 - 3.00)
- ❑ **COMMANDER ON/OFF**
- ❑ **INITIAL SETTINGS** (reset to factory settings)
- ❑ **CLAMP settings** (selection of the optional current clamp adapters BENNING CC 1 (044037), BENNING CC 3 (044038))

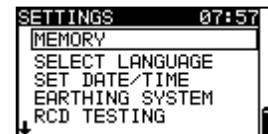

Figure 4.4:
"SETTINGS" mode

Keys used:

UP / DOWN	Selects the respective option
TEST	Confirms the selected option
ESC / function selector switch	Back / cancel without any changes

4.5.1 Memory (IT 130)

In this menu, it is possible to recall stored data and to delete the data of a measuring point or even the entire memory.

Please refer to chapter **6 Management of measured values** for further information.

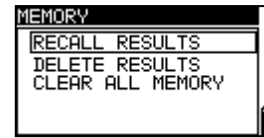

Figure 4.5: Memory options

Keys used:

UP / DOWN	Selects the respective option
TEST	Confirms the selected option
ESC	Back / cancel to the Settings menu
Function selector switch	Back / cancel to the selected measuring function

4.5.2 Language

In this menu, it is possible to select the respective language.



Figure 4.6: Selecting the language

Keys used:

UP / DOWN	Selects the language
TEST	Confirms the selected language and returns to the Settings menu
ESC	Back / cancel to the Settings menu
Function selector switch	Back / cancel to the selected measuring function

4.5.3 Date and time (IT 130)

In this menu, it is possible to set the date and time.

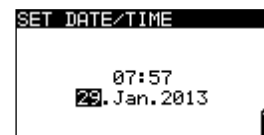

Figure 4.7:
Setting date and time

Keys used:

TAB	Selects the date / time field
UP / DOWN	Modifies the selected field
TEST	Confirms the change and returns to the Settings menu
ESC	Back / cancel to the Settings menu
Function selector switch	Back / cancel to the selected measuring function

Note:

- If the batteries are removed for more than 1 minute, the date and time settings will be lost.

4.5.4 Earthing system (power supply network)

In this menu, it is possible to set the available earthing system (power supply network).

The following options are available:

- TN / TT network
- IT network (IT 130)

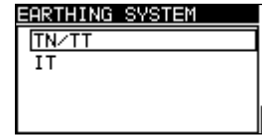

Figure 4.8:
Selecting the earthing system

Keys used:

UP / DOWN	Selects the earthing system
TEST	Confirms the selected earthing system and returns to the Settings menu
ESC	Back / cancel to the Settings menu
Function selector switch	Back / cancel to the selected measuring function

4.5.5 RCD testing

In this menu, it is possible to set the standard used for RCD testing.

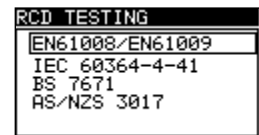

Figure 4.9:
Selecting the RCD standard

Keys used:

UP / DOWN	Selects the standard
TEST	Confirms the selected standard and returns to the Settings menu
ESC	Back / cancel to the Settings menu
Function selector switch	Back / cancel to the selected measuring function

The maximum RCD tripping times vary from standard to standard.

The times specified in the individual standards are listed in the following.

By default, the tripping times in compliance with the EN 60364-4-41 standard are preset. The EN 60364-4-41 standard defines different tripping times for TN/IT networks and TT networks as can be seen in table 41.1.

Tripping times in compliance with **EN 60364-4-41**:

	U_0	$\frac{1}{2} \times I_{\Delta N}^*$	$I_{\Delta N}$	$2 \times I_{\Delta N}$	$5 \times I_{\Delta N}$
TN/IT	$\leq 120 \text{ V}$	$t_{\Delta} > 800 \text{ ms}$	$t_{\Delta} \leq 800 \text{ ms}$	$t_{\Delta} < 150 \text{ ms}$	$t_{\Delta} < 40 \text{ ms}$
	$\leq 230 \text{ V}$	$t_{\Delta} > 400 \text{ ms}$	$t_{\Delta} \leq 400 \text{ ms}$		
TT	$\leq 120 \text{ V}$	$t_{\Delta} > 300 \text{ ms}$	$t_{\Delta} \leq 300 \text{ ms}$		
	$\leq 230 \text{ V}$	$t_{\Delta} > 200 \text{ ms}$	$t_{\Delta} \leq 200 \text{ ms}$		

U_0 : Nominal voltage of external conductor to earth

Example of a tripping time evaluation for $I_{\Delta N}$, U_0 : $\leq 230 \text{ V}$

Setting	Tripping time t_{Δ}	Evaluation field
IEC 60364-4-41 TN/IT	$< 400 \text{ ms}$	✓

	400 ms < t_{Δ} < 999 ms	X
	> 999 ms	X
IEC 60364-4-41 TT	< 200 ms	✓
	200 ms < t_{Δ} < 999 ms	X
	> 999 ms	X

Tripping times in compliance with **EN 61008/EN 61009:**

	$\frac{1}{2} \times I_{\Delta N}^{(*)}$	$I_{\Delta N}$	$2 \times I_{\Delta N}$	$5 \times I_{\Delta N}$
Standard RCDs (undelayed)	$t_{\Delta} > 300$ ms	$t_{\Delta} < 300$ ms	$t_{\Delta} < 150$ ms	$t_{\Delta} < 40$ ms
Selective RCDs (delayed)	$t_{\Delta} > 500$ ms	130 ms < t_{Δ} < 500 ms	60 ms < t_{Δ} < 200 ms	50 ms < t_{Δ} < 150 ms

Tripping times in compliance with **BS 7671:**

	$\frac{1}{2} \times I_{\Delta N}^{(*)}$	$I_{\Delta N}$	$2 \times I_{\Delta N}$	$5 \times I_{\Delta N}$
Standard RCDs (undelayed)	$t_{\Delta} > 1999$ ms	$t_{\Delta} < 300$ ms	$t_{\Delta} < 150$ ms	$t_{\Delta} < 40$ ms
Selective RCDs (delayed)	$t_{\Delta} > 1999$ ms	130 ms < t_{Δ} < 500 ms	60 ms < t_{Δ} < 200 ms	50 ms < t_{Δ} < 150 ms

Tripping times in compliance with **AS/NZS 3017**)**:

RCD type	$I_{\Delta N}$ [mA]	$\frac{1}{2} \times I_{\Delta N}$ ^{*)}	$I_{\Delta N}$	$2 \times I_{\Delta N}$	$5 \times I_{\Delta N}$	Remark
		t_{Δ}	t_{Δ}	t_{Δ}	t_{Δ}	
I	≤ 10	> 999 ms	40 ms	40 ms	40 ms	maximum tripping time
II	$> 10 \leq 30$		300 ms	150 ms	40 ms	
III	> 30		300 ms	150 ms	40 ms	
IV S	> 30	> 999 ms	500 ms	200 ms	150 ms	minimum non-tripping time
			130 ms	60 ms	50 ms	

^{*)} Minimum testing time for a current of $\frac{1}{2} \times I_{\Delta N}$, RCD must not trip

^{**)} Testing current and measuring accuracy correspond to the requirements specified by AS/NZS 3017

Maximum testing times and selected testing current for standard (undelayed) RCDs:

Standard	$\frac{1}{2} \times I_{\Delta N}$	$I_{\Delta N}$	$2 \times I_{\Delta N}$	$5 \times I_{\Delta N}$
EN 60364-4-41	1000 ms	1000 ms	150 ms	40 ms
EN 61008 / EN 61009	300 ms	300 ms	150 ms	40 ms
BS 7671	2000 ms	300 ms	150 ms	40 ms
AS/NZS 3017 (I, II, III)	1000 ms	1000 ms	150 ms	40 ms

Maximum testing times and selected testing current for selective (delayed) RCDs:

Standard	$\frac{1}{2} \times I_{\Delta N}$	$I_{\Delta N}$	$2 \times I_{\Delta N}$	$5 \times I_{\Delta N}$
EN 60364-4-41	1000 ms	1000 ms	200 ms	150 ms
EN 61008 / EN 61009	500 ms	500 ms	200 ms	150 ms
BS 7671	2000 ms	500 ms	200 ms	150 ms
AS / NZS 3017 (IV)	1000 ms	1000 ms	200 ms	150 ms

4.5.6 Isc factor (scaling factor)

In this menu, it is possible to set the Isc factor (scaling factor) for calculating the short-circuit current (I_k) in the functions ZI (L-N/L) and Zs (L-PE).

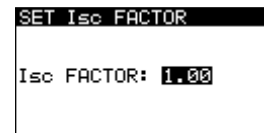

Figure 4.10:
Selecting the Isc factor

Keys used:

UP / DOWN	Modifies the Isc factor
TEST	Confirms the adjusted Isc factor
ESC	Back / cancel to the Settings menu
Function selector switch	Back / cancel to the selected measuring function

The short-circuit current I_k in the power supply system is of particular importance for the selection and testing of protective circuits (fuses, overcurrent protection devices, RCDs). The default value of the Isc factor (I_k) is 1.00. The value has to be set according to local requirements.

The Isc factor can be set within the range of $0.20 \div 3.00$.

4.5.7 Commander ON/OFF

In this menu, it is possible to enable or disable the "Commander" (switchable test probe).

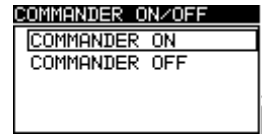

Figure 4.11:
Selecting the "Commander" support

Keys used:

UP / DOWN	Selects Commander ON (enabled) / Commander OFF (disabled)
TEST	Confirms the selected option
ESC	Back / cancel to the Settings menu
Function selector switch	Back / cancel to the selected measuring function

Note:

- ❑ The "Commander OFF" (disabled) option is intended for deactivating the operating keys of the "Commander" (except for the background lighting key). It is useful to disable the "Commander", if strong sources of interference might affect the correct functioning of the "Commander".

4.5.8 Initial settings

In this menu, it is possible to reset the settings, measuring parameters and limiting values of the device to their initial (factory) settings.

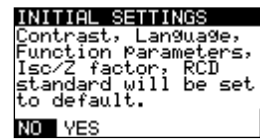

Figure 4.12:
Initial settings dialog

Keys used:

UP / DOWN	Selects the option [YES, NO]
TEST	Confirms the selected option
ESC	Back / cancel to the Settings menu
Function selector switch	Back / cancel to the selected measuring function

Note:

- ❑ If the device is reset to its initial (factory) settings, all settings made will be lost!
- ❑ If the batteries are removed for more than 1 minute, all settings made will be lost.

The initial (factory) settings are defined as follows:

Settings of the device	Default setting
Language	German
Contrast	50 %
Earthing system	TN / TT
Isc factor	1.00
RCD standards	EN 60364-4-41

"Commander" test probe	ON
Current clamp settings	BENNING CC 3
Measuring function Sub-function	Parameter / limiting value
RE	No limiting value
R ISO	without limiting value, nominal testing voltage: 500 V
R LOW	No limiting value
CONTINUITY	No limiting value
ZI (L-N/L) line impedance ΔU voltage drop	Fuse type: none selected ΔU : 4.0 %, Z_{REF} : 0.00 Ω
Zs (L-PE) loop impedance Zsrcd	Fuse type: none selected Fuse type: none selected
RCD	RCD t Nominal differential current: $I_{\Delta N}$ =30 mA RCD type: AC, undelayed Testing current with initial polarity:  (0°) Limiting value for contact voltage: 50 V Nominal differential current multiplier: $\times 1$

Note:

- It is also possible to reset the device to its initial (factory) settings by pressing the "TAB" key when simultaneously switching the device on.

4.5.9 Clamp settings (IT 130)

In the **CLAMP settings** menu, it is possible to configure the C1 measuring input to the current clamp adapter used.

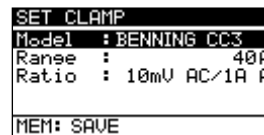

Figure 4.13:
Configuring the current clamp measuring input

Setting parameters:

Type	BENNING CC 1
Measuring range	400 A AC
Type	BENNING CC 3
Measuring range	40 A / 300 A AC / DC

Selecting the parameters

Keys used:

UP / DOWN	Selects the respective options
TEST	Confirms the selected option
MEM	Saves the settings
ESC	Back / cancel to the Settings menu
Function selector switch	Back / cancel to the selected measuring function

Modifying the selected parameters**Keys used:**

UP / DOWN	Modifies the selected parameter
TEST	Confirms the selected parameter
MEM	Saves the settings
ESC	Back / cancel to the Settings menu
Function selector switch	Back / cancel to the selected measuring function

Note:

- Please pay attention to the measuring range of the device. The measuring range of the current clamp might be higher than that of the device.

5 Measurements

5.1 TRMS voltage, frequency and phase sequence

The voltages applied to the testing terminals are permanently displayed by means of the connection monitor. In the **VOLTAGE TRMS** measuring range (true RMS voltage value), the measured values for voltage (AC/DC) and frequency as well as the phase sequence (rotary field) detected can be saved. The measurements are carried out in compliance with the EN 61557-7 standard.

Key function as described in chapter
4.2 Function selector switch

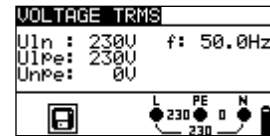

Figure 5.1:
Voltage in a single-phase system

Testing parameters

It is not necessary to set any parameters.

Connection plan

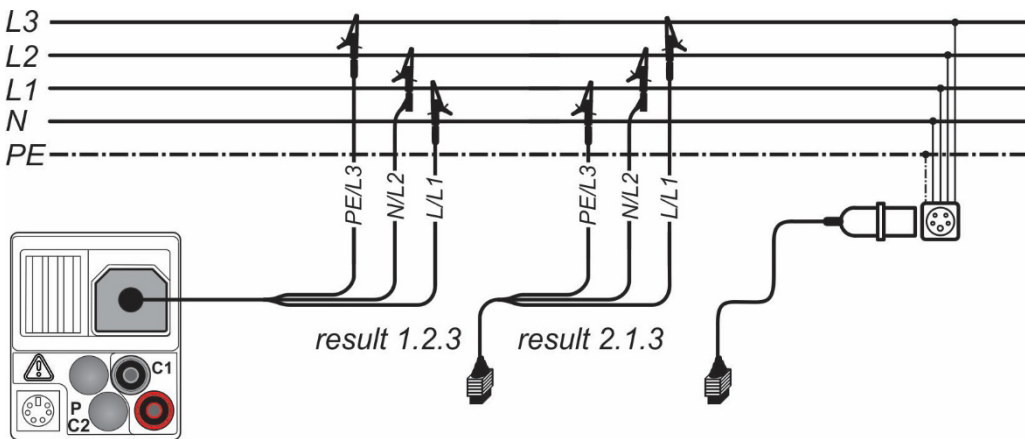

Figure 5.2: Connection of the three-wire test cable and the optional CEE measuring adapter (044148) in a three-phase system
 - Figure using the IT 130 as an example

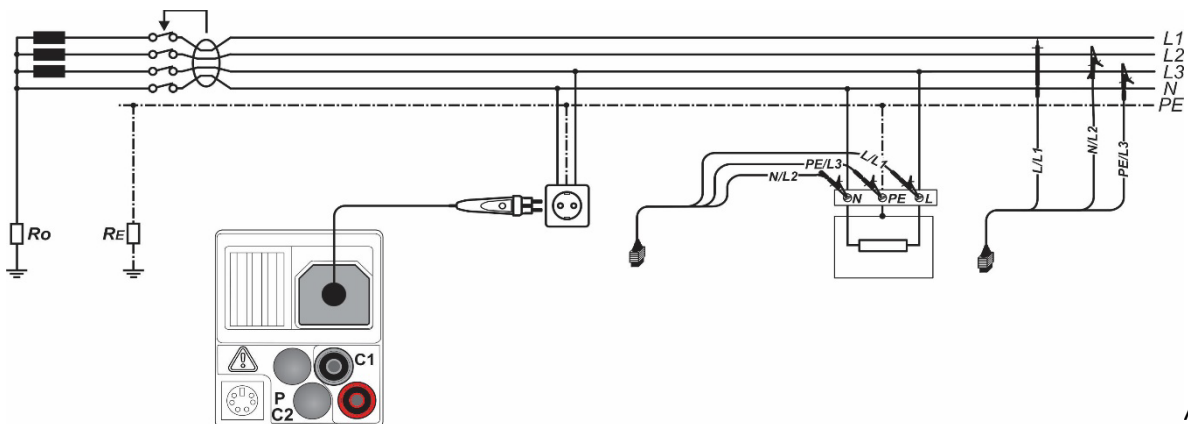

Figure 5.3: Connection of the optional "Commander" test plug (044149) and the three-wire test cable in a single-phase / three-phase system
 - Figure using the IT 130 as an example

How to perform voltage measurements

- ❑ Select the **V_~** function by means of the function selector switch. The display shows **VOLTAGE TRMS**.
- ❑ Connect the test cables to the test object (see figure 5.2 and figure 5.3).
- ❑ Save the measuring result by pressing the "**MEM**" key. (optional for IT 130)

The measurement is performed immediately after the **VOLTAGE TRMS** function has been selected.



Figure 5.4: Examples for voltage measurements in single-phase and three-phase systems

Results displayed for single-phase systems:

- Uln** voltage between phases and neutral conductor
- Uipe** voltage between phase and protective conductor
- Unpe** voltage between neutral and protective conductors
- f** frequency

Results displayed for three-phase systems:

- U12** voltage between testing terminals L1 and L2
- U13** voltage between testing terminals L1 and L3
- U23** voltage between testing terminals L2 and L3
- 1.2.3** correct connection – clockwise phase sequence
- 3.2.1** wrong connection – counter-clockwise phase sequence
- f** frequency

Results displayed for IT systems:

- U12** voltage between testing terminals L1 and L2
- U1pe** voltage between testing terminals L1 and PE
- U2pe** voltage between testing terminals L2 and PE
- f** frequency

5.2 Insulating resistance

The measurement of the insulating resistance is performed in order to prove the proper condition of the insulation and in order to exclude electrical danger.

Typical applications are the following cases:

- ❑ Insulating resistance between the active conductors (L/N) of an installation and the protective conductor / earth (PE) => protection against electric shock,
- ❑ Insulating resistance between the active conductors (L/N) of an installation => protection against short-circuit (over-current) and guarantee of the functional safety,
- ❑ Insulating resistance of non-conductive rooms (walls and floors),
- ❑ Insulating resistance of earthing cables and
- ❑ Resistance of semiconductive (antistatic) floors.

Key function as described in chapter
4.2 Function selector switch

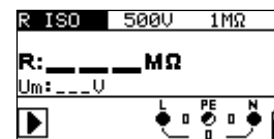

Figure 5.5:
 Insulating resistance

Testing parameters

Uiso	Nominal testing voltage [50 V, 100 V, 250 V, 500 V, 1000 V]
Limiting value	Minimum insulating resistance [without limits (---), 0.01 MΩ ÷ 200 MΩ]

Connection plan

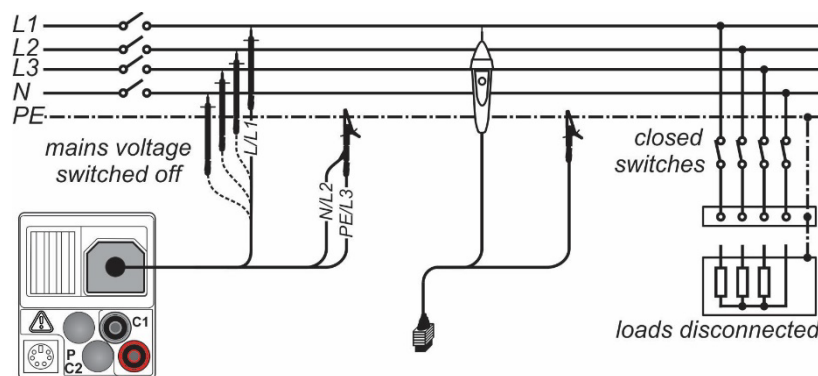

Figure 5.6: Connection of the three-wire test cable and the optional "Commander" test probe
 (044115)
 - Figure using the IT 130 as an example

How to perform insulating resistance measurements

- ❑ Select the **R_{ISO}** function by means of the function selector switch.
 - ❑ Set the required testing voltage and the limiting value (optional).
 - ❑ Make sure that the test object is free of voltage and discharge available capacities.
 - ❑ Connect the test cables to the test object (see figure 5.6).
 - ❑ Press the "**TEST**" key to start the measurement. Double-click the "**TEST**" key (MΩ flashes) to perform a continuous measurement. Press the key again to finish the measurement.
 - ❑ After measurement, wait until the test object is completely discharged.
- Save the measuring result by pressing the "**MEM**" key (optional for IT 130).

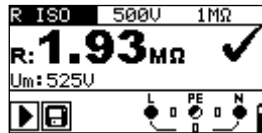

Figure 5.7: Example of an insulating resistance measurement

Results displayed:

- R** insulating resistance
- Um** testing voltage (actual value)

Attention:

- ❑ Measurements of the insulating resistance must be carried out only at test objects which are free of voltage!
- ❑ Disconnect all loads and close all switches for measuring the insulating resistance between conductors of the installation.
- ❑ Do not touch the test object during measurement and before it is completely discharged! There is danger of a life-threatening electric shock!
- ❑ If the insulating resistance measurement is carried out on a capacitive object, automatic discharging might take place time-delayed. The warning symbol and the actual voltage will be displayed during discharging.
- ❑ Do not connect the test cables to external voltages higher than 550 V (AC or DC) in order not to damage the device!

5.3 Low-impedance resistance / continuity test

The measurement of the low-impedance resistance / continuity test is intended for testing the protective conductor, earthing conductor and equipotential bonding conductor connections of an electrical installation.

Two sub-functions are available:

- **R LOWΩ** – resistance measurement in compliance with EN 61557-4 with a testing current of 200 mA and polarity reversal
- **CONTINUITY** – continuous continuity test with a reduced testing current of 7 mA.

Key function as described in chapter
4.2 Function selector switch

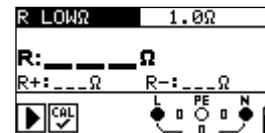

Figure 5.8: Low-impedance resistance $R_{LOW} \Omega$ with a testing current of 200 mA

Testing parameters

Test	Sub-function [R LOWΩ, CONTINUITY]
Limiting value	Maximum resistance [without limits (---), 0.1 Ω ÷ 20.0 Ω]

Additional testing parameter for continuity test sub-function:

	Buzzer ON (sounds if the resistance is lower than the limiting value set) or OFF
--	---

5.3.1 Low-impedance resistance with a testing current of 200 mA

The resistance measurement is performed with automatic polarity reversal of the testing voltage.

Connection plan

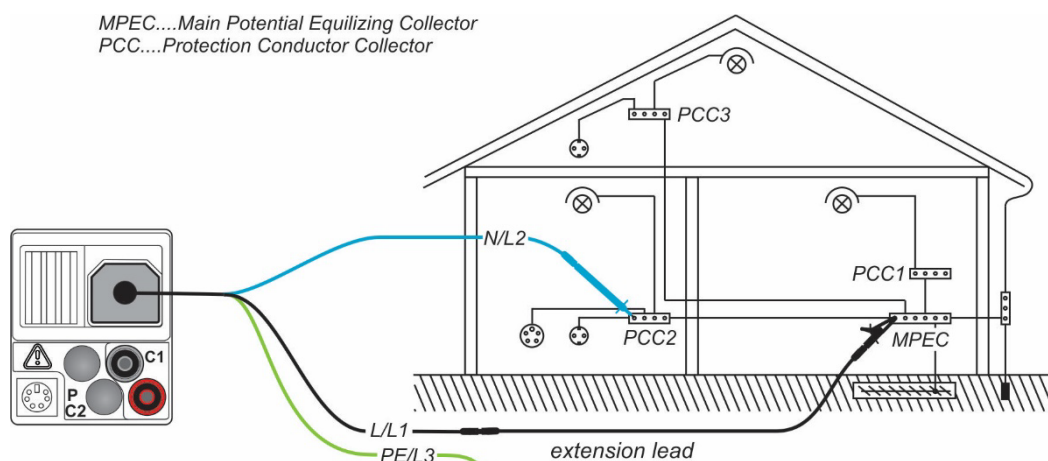

Figure 5.9: Connection of the three-wire test cable and the optional 40 m measuring line BENNING TA 5 (044039)
 - Figure using the IT 130 as an example

How to perform low-impedance measurements R LOW Ω

- ❑ Select the **R_{LOW}** function by means of the function selector switch.
- ❑ Set the sub-function to **R_{LOW Ω}** .
- ❑ Set the limiting value (optional).
- ❑ Connect the test cables to the device and compensate the test cable resistance, if necessary (see section 5.3.3 Compensation (null balance) of the test cable resistance).
- ❑ Make sure that the test object is free of voltage and discharge available capacities.
- ❑ Connect the test cables to the test object (see figure 5.9).
- ❑ Press the "**TEST**" key to start the measurement.

Save the measuring result by pressing the "**MEM**" key (optional for IT 130).

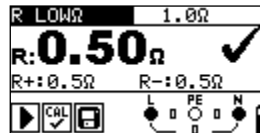

Figure 5.10: Example of a low-impedance measurement RLOW Ω

Results displayed:

- R** R LOW Ω – low-impedance resistance
- R+** partial result at positive polarity
- R-** partial result at negative testing polarity

5.3.2 Continuity test with a testing current of 7 mA

This test function can be compared to the continuity test function of a digital multimeter or of a continuity device with low testing current. The continuous test is done without polarity reversal and can be used for testing inductive components.

Connection plan

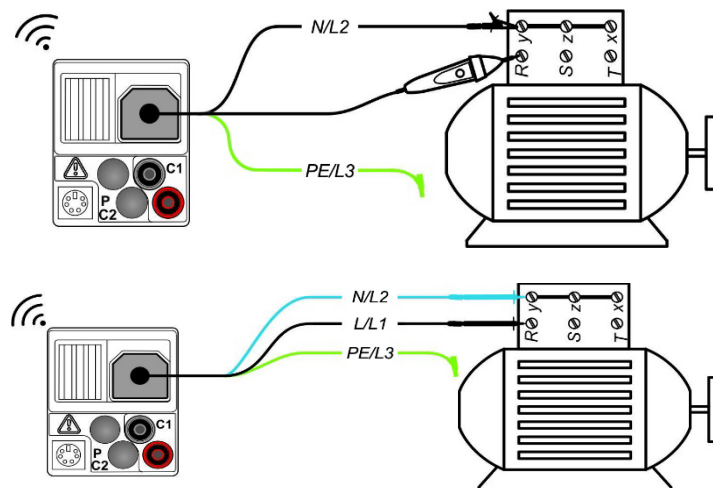

Figure 5.11: Using the "Commander" test probe and the three-wire test cable
- Figure using the IT 130 as an example

How to perform continuity tests

- ❑ Select the **R_{LOW}** function by means of the function selector switch.
- ❑ Set the sub-function to **CONTINUITY**.
- ❑ Set the limiting value (optional).
- ❑ Connect the test cables to the device and compensate the test cable resistance, if necessary (see section 5.3.3 Compensation (null balance) of the test cable resistance).
- ❑ Make sure that the test object is free of voltage and discharge available capacities.
- ❑ Connect the test cables to the test object (see figure 5.11).
- ❑ Press the **"TEST"** key to start the measurement.
- ❑ Press the **"TEST"** key again to stop the measurement.
- ❑ Save the measuring result by pressing the **"MEM"** key (optional for IT 130).

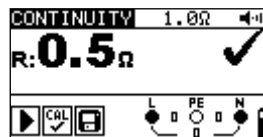



Figure 5.12: Example of a continuity test

Result displayed:

R resistance

5.3.3 Compensation (null balance) of the test cable resistance

This chapter describes how to compensate the test cable resistance in the low-impedance measurement (**R_{LOW}**) and continuity test (**CONTINUITY**) functions. Compensation is necessary, because the test cable resistance and the internal resistance of the device might influence the measuring result. The compensation of the test cables is particularly required when using measuring lines of different lengths.

The  icon is displayed, if the test cable resistance has been compensated successfully.

Connection plan

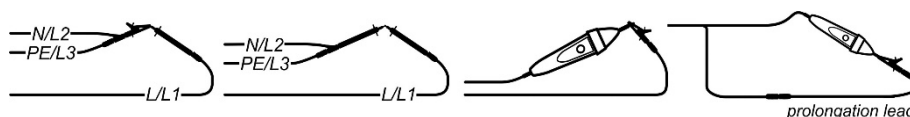

Figure 5.13: Shorted test cables

How to carry out compensation

- ❑ Select the **R_{LOW}** or **CONTINUITY** function.
- ❑ Connect the test cables to the device and short-circuit the test cables (see figure 5.13.)
- ❑ Press the **"TEST"** key to perform the resistance measurement.
- ❑ Press the **"CAL"** key to compensate the test cable resistance.



Figure 5.14: Result before calibration



Figure 5.15: Result after calibration

Note:

- The highest value for test cable compensation is 5 Ω . If the resistance is higher, the compensation value will be reset to the default value.

The  icon is displayed, if the test cable resistance has not been compensated.

5.4 RCD testing

The testing of RCDs in RCD-protected installations requires various tests and measurements. The measurements are based on the EN 61557-6 standard.

The following measurements and tests can be performed:

- Contact voltage, tripping time, tripping current and
- Automatic RCD testing

Key function as described in chapter 4.2 Function selector switch

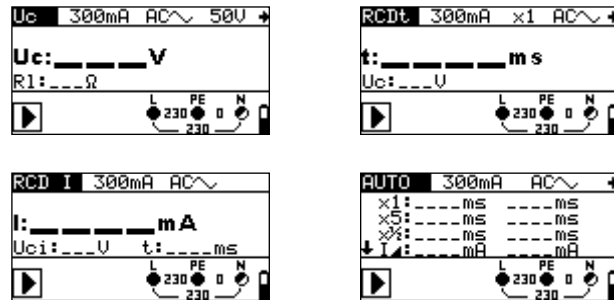

Figure 5.16:
RCD tests

Testing parameters (IT 115)

Test	Sub-function [Uc, RCDt, RCD I, AUTO]
$I_{\Delta N}$	Nominal tripping differential current $I_{\Delta N}$ [10 mA, 30 mA, 100 mA, 300 mA, 500 mA, 1000 mA]
RCD type	Type [AC, A, F] Initial polarity [~ , ~ , ~ , ~] Properties [selective <input checked="" type="checkbox"/> , standard undelayed <input type="checkbox"/> , PRCD, PRCD-S, PRCD-K]
MUL	Multiplier of testing current [$\frac{1}{2}x$, 1x, 2 x, 5x $I_{\Delta N}$]
Ulim	Limiting value of contact voltage [25 V, 50 V]

Testing parameters (IT 130)

Test	Sub-function [Uc, RCDt, RCD I, AUTO]
$I_{\Delta N}$	Nominal tripping differential current $I_{\Delta N}$ [10 mA, 30 mA, 100 mA, 300 mA, 500 mA, 1000 mA]
RCD type	Type [AC, A, F, B, B+] Initial polarity [~ , ~ , ~ , ~ , ⊕ , ⊖] Properties [selective <input checked="" type="checkbox"/> , standard undelayed <input type="checkbox"/> , PRCD, PRCD-S, PRCD-K, EV RCD, MI RCD].
MUL	Multiplier of testing current [$\frac{1}{2}x$, 1x, 2 x, 5x $I_{\Delta N}$]
Ulim	Limiting value of contact voltage [25 V, 50 V]

Note:

- The limiting value of the contact voltage can be set only in the Uc sub-function.
- Selective (delayed) RCDs have delayed tripping times. As the contact voltage measurement and other RCD tests influence delayed RCDs, it takes a certain time until they have returned to their normal condition. For this reason, a time delay of 30 seconds is added before the standard tripping test is performed.

- ❑ During testing of some portable PRCDs (e.g. PRCD-K) in which the protective conductor is guided through the converter in opposite direction, this portable RCD trips already at the 0.5-fold value of the nominal tripping differential current. The device evaluates the early tripping as "accidental tripping" and aborts the test without any measuring result. If this test has been carried out with a positive result, i.e. it has been proven that the portable PRCD trips at the 0.5-fold value of the nominal tripping differential current and thus the protective conductor is not interrupted, it is possible to continue the test by changing the contacting of the protective conductor. In this case, it is necessary to establish a contact to the protective conductor (PE) of an adjacent socket instead of establishing a contact to the protective conductor (PE) of the coupling socket for further testing. Then, the test can be performed just as for an ordinary RCD.
- ❑ Testing of the AC function of the RCDs of types EV and MI is performed in the same way as for a general (non-delayed) RCD. (IT 130)
- ❑ Testing of the DC function of the RCDs of type EV is performed with a direct current in accordance with the standard IEC 62955. (IT 130)
- ❑ Testing of the DC function of the RCDs of type MI is performed with a direct current, whereby the thresholds of the tripping time and the tripping current are identical to those of the tests of the RCDs of type B. (IT 130)

Connection plan

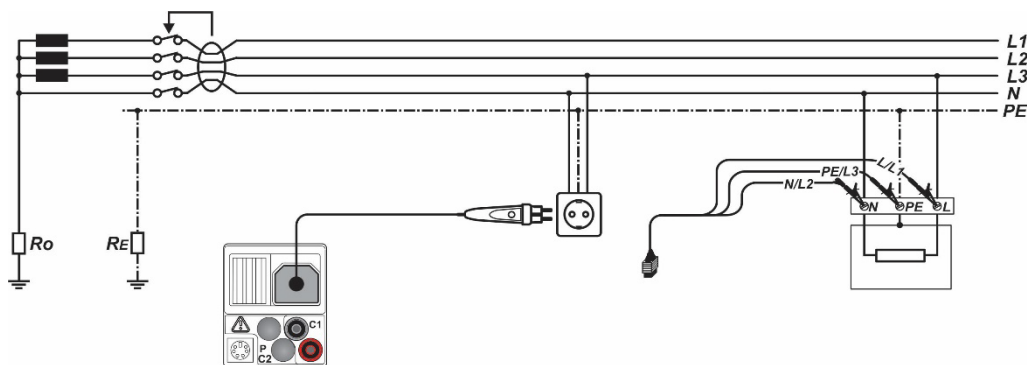

Figure 5.17: Connection of the optional "Commander" test plug (044149) and the three-wire test cable - Figure using the IT 130 as an example

5.4.1 Contact voltage (Uc)

Leakage current flowing to earth via the protective conductor connection causes a voltage drop at the earthing resistance, i.e. a voltage difference between the PE equipotential bonding and earth. This voltage difference is called contact voltage and is applied to all accessible conductive parts connected to protective earth (PE). The contact voltage always should be lower than the maximum admissible contact voltage. Contact voltage is measured with a testing current lower than $\frac{1}{2} I_{\Delta N}$ in order to avoid tripping of the RCD and then to be normalized to the nominal value $I_{\Delta N}$.

How to perform contact voltage measurements

- ❑ Select the **F/RCD** function by means of the function selector switch.
- ❑ Set the sub-function to **Uc**.
- ❑ Set the testing parameters.
- ❑ Connect the test cables to the test object (see figure 5.17).
- ❑ Press the **"TEST"** key to start the measurement.
- ❑ Save the measuring result by pressing the **"MEM"** key (optional for IT 130).

The contact voltage displayed refers to the rated differential current of the RCD and is multiplied with an appropriate factor for safety reasons. The factor 1.05 is applied in order to avoid a negative tolerance of the result.

Calculation of the contact voltage for the IT 115

RCD type		Contact voltage U_c proportional to	Nominal value $I_{\Delta N}$
AC	<input type="checkbox"/>	$1.05 \times I_{\Delta N}$	any
AC	<input checked="" type="checkbox"/>	$2 \times 1.05 \times I_{\Delta N}$	
A, F	<input type="checkbox"/>	$1.4 \times 1.05 \times I_{\Delta N}$	$\geq 30 \text{ mA}$
A, F	<input checked="" type="checkbox"/>	$2 \times 1.4 \times 1.05 \times I_{\Delta N}$	
A, F	<input type="checkbox"/>	$2 \times 1.05 \times I_{\Delta N}$	$< 30 \text{ mA}$
A, F	<input checked="" type="checkbox"/>	$2 \times 2 \times 1.05 \times I_{\Delta N}$	

Table 5.1: Ratio between U_c and $I_{\Delta N}$ (IT 115)

Calculation of the contact voltage for the IT 130

RCD type		Contact voltage U_c proportional to	Nominal value $I_{\Delta N}$
AC, EV/MI (AC part)	<input type="checkbox"/>	$1.05 \times I_{\Delta N}$	any
AC	<input checked="" type="checkbox"/>	$2 \times 1.05 \times I_{\Delta N}$	
A, F	<input type="checkbox"/>	$1.4 \times 1.05 \times I_{\Delta N}$	$\geq 30 \text{ mA}$
A, F	<input checked="" type="checkbox"/>	$2 \times 1.4 \times 1.05 \times I_{\Delta N}$	
A, F	<input type="checkbox"/>	$2 \times 1.05 \times I_{\Delta N}$	$< 30 \text{ mA}$
A, F	<input checked="" type="checkbox"/>	$2 \times 2 \times 1.05 \times I_{\Delta N}$	
EV/MI (AC part)	<input type="checkbox"/>	$1.05 \times I_{\Delta N}$	30 mA
B, B+	<input type="checkbox"/>	$2 \times 1.05 \times I_{\Delta N}$	any
B, B+	<input checked="" type="checkbox"/>	$2 \times 2 \times 1.05 \times I_{\Delta N}$	

Table 5.1: Ratio between U_c and $I_{\Delta N}$ (IT 130)

The loop resistance is a purely indicative value and is calculated from the contact voltage

(without additional proportional factors). $R_L = \frac{U_c}{I_{\Delta N}}$.

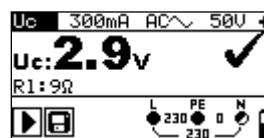

Figure 5.18: Example of a contact voltage measurement

Results displayed:

Uccontact voltage

RLloop resistance (fault loop resistance)

5.4.2 Tripping time (RCDt)

The tripping time measurement serves to test the sensitivity of the residual current protection devices (RCDs) at different nominal tripping differential currents $I_{\Delta N}$.

How to perform tripping time measurements

- Select the **F/RCD** function by means of the function selector switch.
- Set the sub-function to **RCDt**.
- Set the testing parameters.
- Connect the test cables to the test object (see figure 5.17).
- Press the **"TEST"** key to start the measurement.
- Save the measuring result by pressing the **"MEM"** key (optional for IT 130).

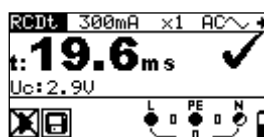

Figure 5.19: Example of a tripping time measurement

Result displayed:

- t.....tripping time
- Uccontact Voltage

5.4.3 Tripping current (RCD I)

For tripping current measurement, a continuously increasing fault current serves to determine the limiting sensitivity for RCD tripping. The device increases the fault current in small steps within the whole range as follows:

Norm **EN 60364-4-41**, (SETTINGS mode → RCD TESTING):

Calculation of the tripping current with the IT 115

RCD type	Increasing fault current		Curve shape
	Initial value	Final value	
AC	$0,1 \times I_{\Delta N}$	$1,1 \times I_{\Delta N}$	sinusoidal
A, F ($I_{\Delta N} \geq 30 \text{ mA}$)	$0,1 \times I_{\Delta N}$	$1,5 \times I_{\Delta N}$	pulsating
A, F ($I_{\Delta N} = 10 \text{ mA}$)	$0,1 \times I_{\Delta N}$	$2,2 \times I_{\Delta N}$	

Calculation of the tripping current with the IT 130

RCD type	Increasing fault current		Curve shape
	Initial value	Final value	
AC, EV/MI (AC part)	$0.1 \times I_{\Delta N}$	$1.1 \times I_{\Delta N}$	sinusoidal
A, F ($I_{\Delta N} \geq 30 \text{ mA}$)	$0.1 \times I_{\Delta N}$	$1.5 \times I_{\Delta N}$	pulsating
A, F ($I_{\Delta N} = 10 \text{ mA}$)	$0.1 \times I_{\Delta N}$	$2.2 \times I_{\Delta N}$	
EV/MI (AC part)	$0.1 \times I_{\Delta N}$	$1.1 \times I_{\Delta N}$	sinusoidal
B, B+, MI (DC part)	$0.1 \times I_{\Delta N}$	$2.2 \times I_{\Delta N}$	DC
EV (DC part)	1.2 mA	6.0 mA	DC

Norm **EN 61008/EN 61009**, (SETTINGS mode → RCD TESTING):

Calculation of the tripping current with the IT 115

RCD type	Increasing fault current		Curve shape
	Initial value	Final value	
AC	$0,2 \times I_{\Delta N}$	$1,1 \times I_{\Delta N}$	sinusoidal
A, F ($I_{\Delta N} \geq 30 \text{ mA}$)	$0,2 \times I_{\Delta N}$	$1,5 \times I_{\Delta N}$	pulsating
A, F ($I_{\Delta N} = 10 \text{ mA}$)	$0,2 \times I_{\Delta N}$	$2,2 \times I_{\Delta N}$	

Calculation of the tripping current with the IT 130

RCD type	Increasing fault current		Curve shape
	Initial value	Final value	
AC, EV/MI (AC part)	$0.2 \times I_{\Delta N}$	$1.1 \times I_{\Delta N}$	sinusoidal
A, F ($I_{\Delta N} \geq 30 \text{ mA}$)	$0.2 \times I_{\Delta N}$	$1.5 \times I_{\Delta N}$	pulsating
A, F ($I_{\Delta N} = 10 \text{ mA}$)	$0.2 \times I_{\Delta N}$	$2.2 \times I_{\Delta N}$	
EV/MI (AC part)	$0.2 \times I_{\Delta N}$	$1.1 \times I_{\Delta N}$	sinusoidal
B, B+, MI (DC part)	$0.2 \times I_{\Delta N}$	$2.2 \times I_{\Delta N}$	DC
EV (DC part)	1.2 mA	6.0 mA	DC

The maximum testing current is I_{Δ} (tripping current) or corresponds to the final value, if the RCD does not trip.

How to perform tripping current measurements

- Select the **FI/RCD** function by means of the function selector switch.
- Set the sub-function to **RCD I**.
- Set the testing parameters.
- Connect the test cables to the test object (see figure 5.17).
- Press the **"TEST"** key to start the measurement.
- Save the measuring result by pressing the **"MEM"** key (optional).



Figure 5.20: Example of a tripping current measurement

Results displayed:

Itripping current

Ucicontact voltage at tripping current I or final value, if RCD does not trip

t.....tripping time

5.4.4 Automatic test

The automatic RCD test is intended to perform a complete RCD test (tripping time at different fault currents, tripping current and contact voltage) in a sequence of automatic tests controlled by the device.

Additional key

HELP / DISPLAY	As soon as measurement is finished, the "HELP" key toggles between the upper and lower part of the result field.
-----------------------	--

How to perform an automatic test

Steps of the automatic test	Note
<ul style="list-style-type: none"> <input type="checkbox"/> Select the F/RCD function by means of the function selector switch. <input type="checkbox"/> Set the sub-function to AUTO. <input type="checkbox"/> Set the testing parameters. <input type="checkbox"/> Connect the test cables to the test object (see figure 5.17). <input type="checkbox"/> Press the "TEST" key to start the measurement. 	Start of test
<ul style="list-style-type: none"> <input type="checkbox"/> Testing with $I_{\Delta N}$, 0° (step 1) 	RCD should trip
<ul style="list-style-type: none"> <input type="checkbox"/> Activating the RCD <input type="checkbox"/> Testing with $I_{\Delta N}$, 180° (step 2) 	RCD should trip
<ul style="list-style-type: none"> <input type="checkbox"/> Activating the RCD <input type="checkbox"/> Testing with $5 \times I_{\Delta N}$, 0° (step 3) 	RCD should trip
<ul style="list-style-type: none"> <input type="checkbox"/> Activating the RCD <input type="checkbox"/> Testing with $5 \times I_{\Delta N}$, 180° (step 4) 	RCD should trip
<ul style="list-style-type: none"> <input type="checkbox"/> Activating the RCD <input type="checkbox"/> Testing with $\frac{1}{2} \times I_{\Delta N}$, 0° (step 5) <input type="checkbox"/> Testing with $\frac{1}{2} \times I_{\Delta N}$, 180° (step 6) 	RCD must not trip RCD must not trip
<ul style="list-style-type: none"> <input type="checkbox"/> Tripping current test, 0° (step 7) 	RCD should trip
<ul style="list-style-type: none"> <input type="checkbox"/> Activating the RCD <input type="checkbox"/> Tripping current test, 180° (step 8) 	RCD should trip
<ul style="list-style-type: none"> <input type="checkbox"/> Activating the RCD <input type="checkbox"/> Save the measuring result by pressing the "MEM" key (optional for IT 130). 	End of test

Example of the test steps:

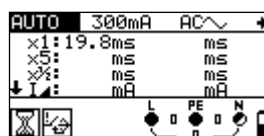

Step 1

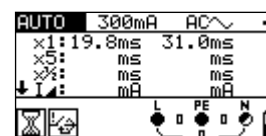

Step 2

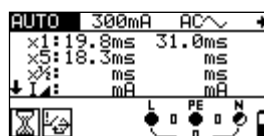

Step 3

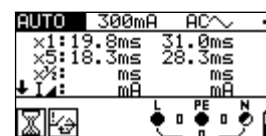

Step 4



Figure 5.21: Test steps of the automatic test



Figure 5.22: The "HELP" key toggles between the upper and the lower part of the result field.

Results displayed:

- x1step 1 tripping time ($I_{\Delta}=I_{\Delta N}$, 0°)
- x1step 2 tripping time ($I_{\Delta}=I_{\Delta N}$, 180°)
- x5step 3 tripping time ($I_{\Delta}=5 \times I_{\Delta N}$, 0°)
- x5step 4 tripping time ($I_{\Delta}=5 \times I_{\Delta N}$, 180°)
- x $\frac{1}{2}$ step 5 tripping time ($I_{\Delta}=\frac{1}{2} \times I_{\Delta N}$, 0°)
- x $\frac{1}{2}$ step 6 tripping time ($I_{\Delta}=\frac{1}{2} \times I_{\Delta N}$, 180°)
- I Δ step 7 tripping current (0°)
- I Δ step 8 tripping current (180°)
- Uccontact voltage for nominal value $I_{\Delta N}$

Notes:

- The automatic test will be stopped immediately, if any invalid condition is detected, e.g. exceedance of the maximum admissible contact voltage or a tripping time outside the admissible range.
- During the automatic testing of RCDs of the types A and F with nominal tripping differential currents of 300 mA, 500 mA and 1000 mA, the test of $5 \times I_{\Delta N}$ will not be carried out. In this case, the test shall be passed, if all other test have been passed.
- The tripping current measurement (I Δ , steps 7 and 8) is not carried out for selective RCDs.
- In the automatic test, the tripping time of RCDs of types B and B+ is measured with a sinusoidal testing current. The tripping current is measured with a smooth DC fault current. (IT 130)
- In the automatic test, the tripping time and tripping current for the AC part of RCDs of types EV and MI are measured with a sinusoidal testing current. The tripping current for the DC part is measured with a smooth DC fault current. (IT 130)

5.5 Loop impedance and prospective short-circuit current

The loop impedance is a complex AC current resistance within a fault loop (earth fault L-PE) consisting of current source, external conductor and protective conductor. The device measures the impedance of the loop and calculates the short-circuit current. The measurement complies with the requirements specified in the EN 61557-3 standard.

Key function as described in chapter
4.2 Function selector switch

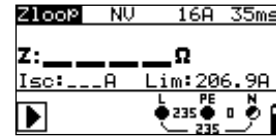

Figure 5.23:
 Loop impedance

Testing parameters

Test	Selects the loop impedance sub-function [Zloop , Zsrcd]
Testing current	Selects the testing current [Std , Low] (standard, low)
Fuse type	Selects the fuse type [---, NV , gG , B , C , K , D , Z , L , U]
Nominal current	Nominal current of the fuse
Tripping time	Maximum tripping time of the fuse
Lim (limiting value)	Lower limit of the prospective short-circuit current

See Appendix A "Fuse table".

Connection plan

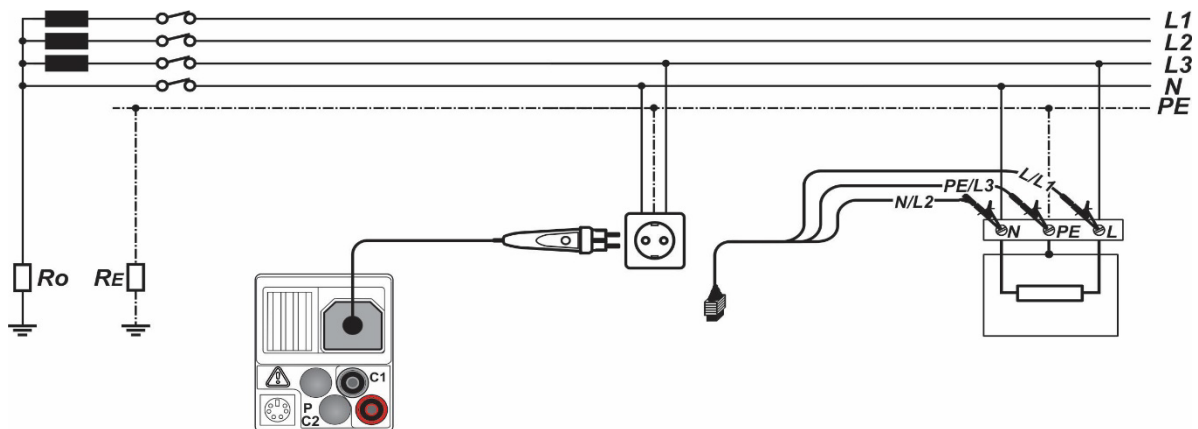

Figure 5.24: Connection of the optional "Commander" test plug (044149) and the three-wire test cable - Figure using the IT 130 as an example

How to perform loop impedance measurements

- ❑ Select the **Z_{Loop} (L-PE)** function by means of the function selector switch.
- ❑ Set the sub-function to **Z_{loop}** or **Z_{srcd}** (for systems with RCDs).
- ❑ Set the testing parameters.
- ❑ Connect the test cables to the test object (see figure 5.24).
- ❑ Press the **"TEST"** key to start the measurement.
- ❑ Save the measuring result by pressing the **"MEM"** key (optional for IT 130).

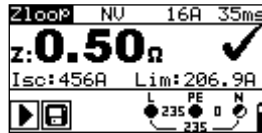

Figure 5.25: Example of a loop impedance measurement

Results displayed:

- Z**..... loop impedance
- I_{sc}** prospective short-circuit current
- Lim**..... lower limit of the prospective short-circuit current

The prospective short-circuit current I_{SC} is calculated as follows:

$$I_{SC} = \frac{U_n \times k_{SC}}{Z}$$

with:

U_n nominal voltage L-PE (see table below),

k_{sc} correction factor for short-circuit current I_{sc} (see chapter 4.4.6 *I_{sc} factor (scaling factor)*)

U_n	Voltage range (L-PE)
110 V	(93 V ≤ U_{L-PE} ≤ 134 V)
230 V	(185 V ≤ U_{L-PE} ≤ 266 V)

Notes:

- ❑ High fluctuations of the nominal voltage might influence the measuring results ( icon on the LC display). In this case, it is recommended to repeat the measurements and to check whether the measuring results are stable.
- ❑ The loop impedance measurement Z_{loop} trips the residual current protection devices (RCDs).
- ❑ Select the Z_{srcd} measurement in order to prevent the tripping of a residual current protection device (RCD).
- ❑ The Z_{srcd} measurement normally does not trip the RCD. However, if a leakage current flows from L to PE, or if a very sensitive RCD is installed (e.g. EV type), the RCD may trip. In this case, setting the parameter "testing current" to "low" can be helpful.

5.6 Line impedance and prospective short-circuit current / voltage drop

The line impedance is a complex AC resistance within a current loop (short-circuit L-N or L-L) consisting of current source, external and neutral conductor (single-phase system) or between two external conductors (three-phase system).

The line impedance measurement complies with the requirements specified in the EN 61557-3 standard.

The "voltage drop" sub-function is intended to check whether a voltage in an electrical installation remains above an admissible value, if the maximum nominal current of the upstream fuse is flowing in the circuit. The limiting values are described in the EN 60364-5-52 standard.

Sub-functions:

- **Zline** – line impedance measurement in compliance with EN 61557-3 and
- **ΔU** – voltage drop measurement

Key function as described in chapter
4.2 Function selector switch

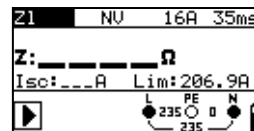

Figure 5.26:
Line impedance

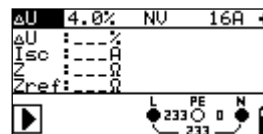

Figure 5.27:
Voltage drop

Testing parameters

Test	Sub-functions Zline , ΔU
Fuse type	Selects the fuse type [---, NV, gG, B, C, K, D, Z, L, U]
Nominal current	Nominal current of the fuse
Tripping time	Maximum tripping time of the fuse
Lim (limiting value)	Lower limit of the prospective short-circuit current

See Appendix A "Fuse table".

Additional testing parameter for voltage drop measurement:

ΔU_{MAX}	Maximum voltage drop [3.0 % ÷ 9.0 %]
-------------------------	---

5.6.1 Line impedance and prospective short-circuit current

Connection plan

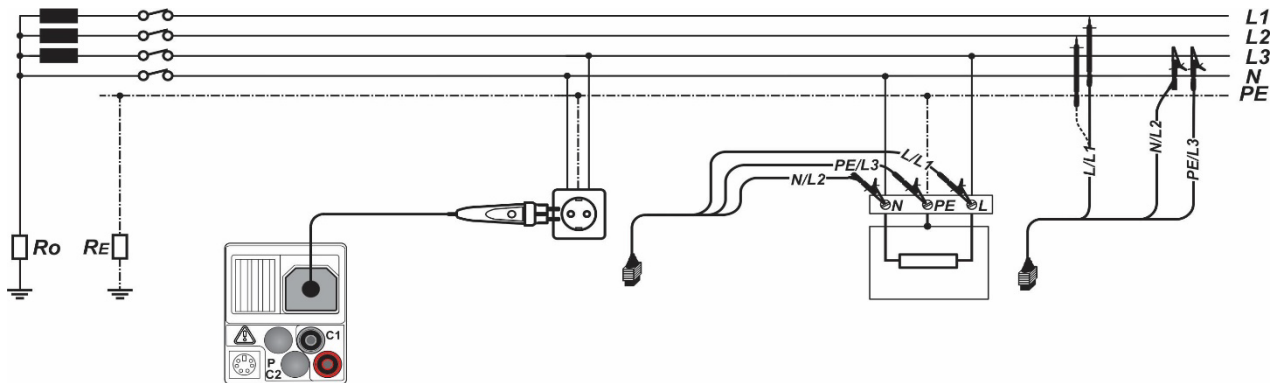

Figure 5.28: Connection of the optional "Commander" test plug (044149) and the three-wire test cable - Figure using the IT 130 as an example

How to perform line impedance measurements

- Select the **Z_{LINE} (L-N/L)** function by means of the function selector switch.
- Set the sub-function to **Z_{line}**.
- Set the testing parameters.
- Connect the test cables to the test object (see figure 5.28).
- Press the **"TEST"** key to start the measurement.
- Save the measuring result by pressing the **"MEM"** key (optional for IT 130).



Figure 5.29: Example of a line impedance measurement

Results displayed:

Z..... line impedance

Isc..... prospective short-circuit current

Lim..... lower limit of the prospective short-circuit current

The prospective short-circuit current is calculated as follows:

$$I_{sc} = \frac{U_n \times k_{sc}}{Z}$$

with:

U_n.....nominal voltage L-N or L1-L2 (see table below),

k_{sc}.....correction factor for short-circuit current I_{sc} (see chapter 4.4.6 I_{sc} factor (scaling factor))

U _n	Voltage range (L-N or L1-L2)
110 V	(93 V ≤ U _{L-N} < 134 V)
230 V	(185 V ≤ U _{L-N} ≤ 266 V)
400 V	(321 V < U _{L-L} ≤ 485 V)

Note:

- High fluctuations of the nominal voltage might influence the measuring results (📊 icon on the LC display). In this case, it is recommended to repeat the measurements and to check whether the measuring results are stable.

5.6.2 Voltage drop

Voltage drop calculation is based on the difference between the line impedance at the measuring point (e.g. socket) and the line impedance at the reference point (e.g. distribution).

Connection plan

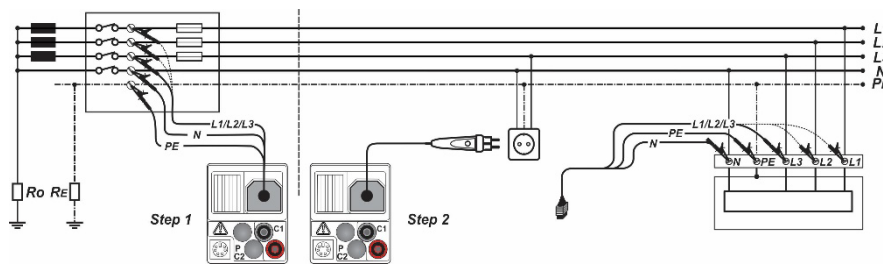

Figure 5.30: Connection of the optional "Commander" test plug (044149) and the three-wire test cable - Figure using the IT 130 as an example

How to perform voltage drop measurements

Step 1: Measuring the impedance Z_{ref} at the reference point

- Select the **Z_{LINE} (L-N/L)** function by means of the function selector switch.
- Set the sub-function to **ΔU**.
- Set the testing parameters.
- Connect the test cables to the test object (see figure 5.30).
- Press the "**CAL**" key to start the measurement.

Step 2: Measuring the voltage drop at the measuring point

- Set the sub-function to **ΔU**.
- Set the testing parameters (the fuse type has to be selected).
- Connect the test cables to the test object (see figure 5.30).
- Press the "**TEST**" key to start the measurement.
- Save the measuring result by pressing the "**MEM**" key (optional).

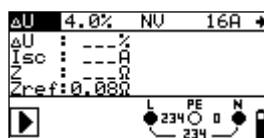

Step 1 - Zref

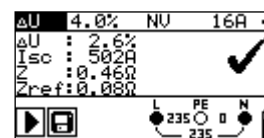

Step 2 - Voltage drop

Figure 5.31: Example of a voltage drop measurement

Results displayed:

- ΔU** voltage drop
- I_{sc}** prospective short-circuit current
- Z** line impedance at the measuring point
- Z_{ref}** line impedance at the reference point

The voltage drop is calculated as follows:

$$\Delta U[\%] = \frac{(Z - Z_{REF}) \cdot I_N}{U_N} \cdot 100$$

with:

- ΔU** calculated voltage drop
- Z** line impedance at the measuring point
- Z_{REF}** line impedance at the reference point
- I_N** nominal current of the fuse
- U_N** nominal voltage (see table below)

U _n	Voltage range (L-N or L1-L2)
110 V	(93 V ≤ U _{L-N} < 134 V)
230 V	(185 V ≤ U _{L-N} ≤ 266 V)
400 V	(321 V < U _{L-L} ≤ 485 V)

Notes:

- ❑ If the reference impedance is not set, Z_{REF} is assumed to be 0.00 Ω.
- ❑ The Z_{REF} value is deleted (set to 0.00 Ω) by pressing the "CAL" key, if the device is not connected to a voltage source.
- ❑ The I_{SC} value is calculated as described in chapter 5.6.1 "Line impedance and prospective short-circuit current".
- ❑ If the voltage measured is outside the listed voltage ranges, the ΔU value will not be calculated.
- ❑ High fluctuations of the nominal voltage might influence the measuring results (⚡ icon on the LC display). In this case, it is recommended to repeat the measurements and to check whether the measuring results are stable.

5.7 Earthing resistance

An adequate and reliably effective earth connection is an important prerequisite for the correct functioning and safety of electrical installations.

In combination with the optional earthing kit (044113), it is possible to perform earthing resistance measurements at main earthing systems, lightning arresters and local earth connections. The measurement complies with the EN 61557-5 standard.

Earthing resistance measurement is performed using the three-wire measuring method by means of two earth rods.

Key function as described in chapter

4.2 Function selector switch

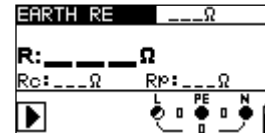

Figure 5.32: Earthing resistance

Testing parameters

Limiting value	Maximum resistance [without limits (---), $1 \Omega \div 5 \text{ k}\Omega$]
-----------------------	---

How to perform earthing resistance measurements

- Select the **R_E** function by means of the function selector switch. The display shows **EARTH RE**.
- Set the limiting value (optional).
- Connect the test cables to the test object (see figure 5.33 and 5.34)
- Press the "TEST" key to start the measurement.
- Save the measuring result by pressing the "MEM" key (optional).

Connection plan

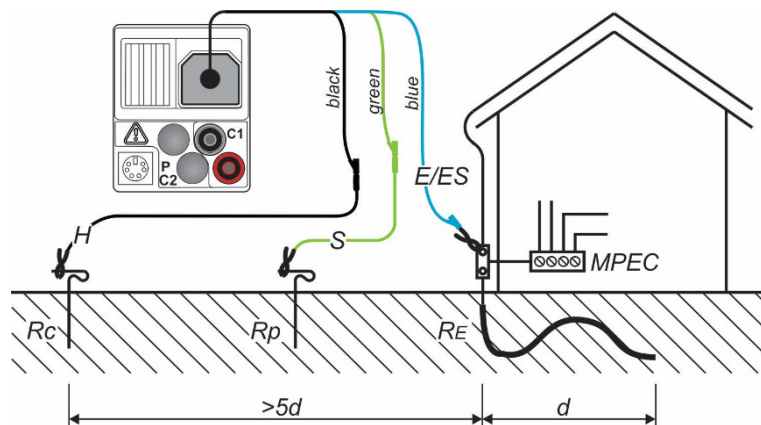

Figure 5.33: Connection of the optional earthing kit (044113)
– Measurement of the main earthing system - Figure using the IT 130 as an example

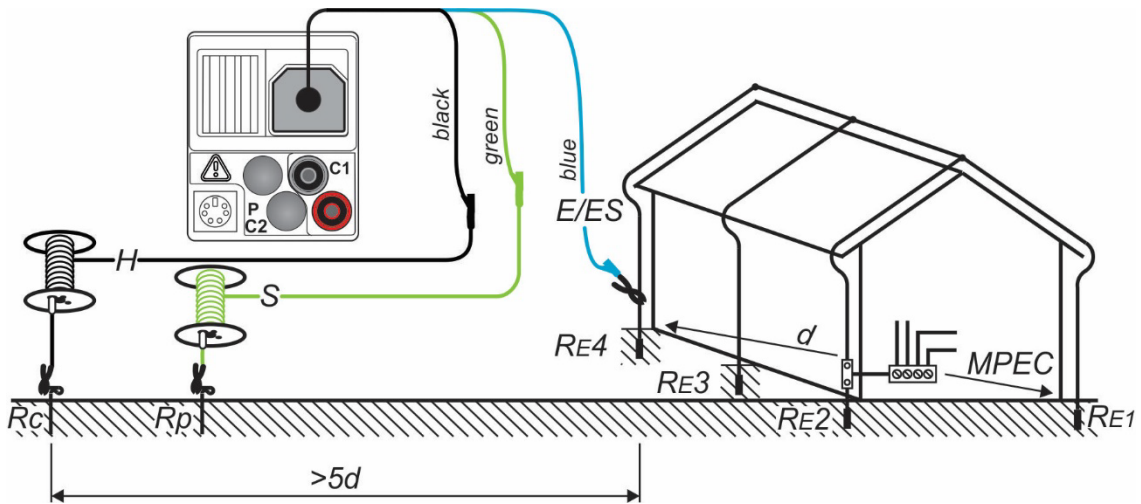

Figure 5.34: Connection of the optional earthing kit (044113)
 – Measurement at the lightning arrester - Figure using the IT 130 as an example



Figure 5.35: Example of an earthing resistance measurement

Results displayed:

- R** earthing resistance
- R_p** resistance of the S probe, probe resistance (potential)
- R_c** resistance of the H probe, auxiliary earth electrode resistance (current)

Notes:

- An excessive resistance of the S and H probes might influence the measuring results. In this case, the warnings “Rp” and “Rc” will be displayed. The results will not be evaluated with "PASS" / "FAIL".
- High parasitic currents and interference voltages might influence the measuring results. In this case, the device displays the  warning.
- The probes must be positioned with sufficient distance from the test object. The distance between the earth connection (E/ES) and the probe (H) should be at least five times larger than the depth or length of the earth connection (see figures 5.33 and 5.34).

5.8 Testing the protective conductor connection (PE)

In case of new or modified installations, it might happen that the protective conductor (PE) and the external conductor L (phase) have been accidentally reversed. This is a very dangerous situation! For this reason, it is important to check whether a dangerous phase voltage is applied to the protective conductor connection.

The test of the protective conductor connection is performed automatically for the **Zline (L-N/L)**, **Zloop (L-PE)** and **RCD** measuring functions by touching (> 1 second) the silver "TEST" key of the device, of the "Commander" test probe or the optional "Commander" test plug (044149).

Examples of incorrect wiring of the protective conductor connection (PE)

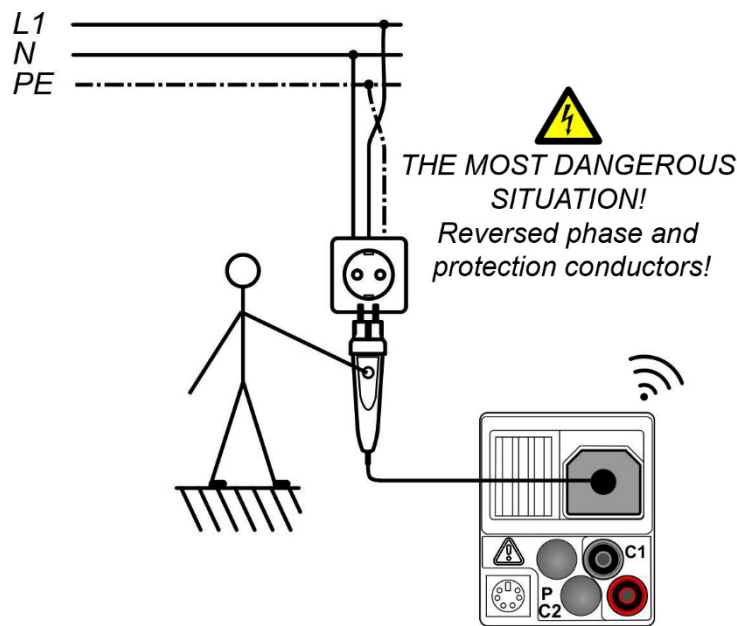

Figure 5.36: Reversed L and PE conductors – Phase voltage at the PE conductor is detected by touching the "TEST" key of the "Commander" test plug (optional).
- Figure using the IT 130 as an example

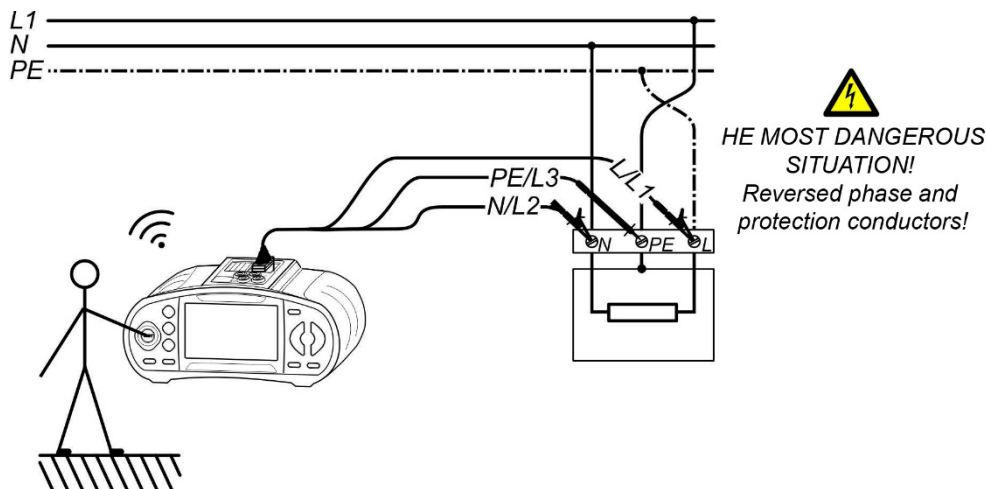



Figure 5.37: Reversed L and PE conductors – Phase voltage at the PE conductor is detected by touching the "TEST" key of the device

Testing the protective conductor connection (PE)

- ❑ Select the **Z_{LINE} (L-N/L)**, **Z_{LOOP} (L-PE)** or **RCD** function by means of the function selector switch.
- ❑ Connect the test cables to the test object (see figure 5.36 and 5.37).
- ❑ Touch the silver contact electrode of the "TEST" key for at least two seconds.
- ❑ If phase voltage is connected to the PE connection, the  warning is shown on the LC display of the device and the buzzer sounds. Further measurements in the **Z_{loop} (L-PE)** and **RCD** functions are blocked.

Warning:

- ❑ If the phase voltage is detected at the protective conductor connection (PE), immediately stop all measurements and make sure that the fault will be eliminated.

Notes:

- ❑ The protective conductor connection can only be tested in the **Z_{LINE} (L-N/L)**, **Z_{LOOP} (L-PE)** or **RCD** positions of the function selector switch.
- ❑ A phase voltage at the protective conductor will not be detected, if the operator's body is completely insulated from the floor or the walls!
- ❑ See Appendix C "Commander".

5.9 TRMS current by means of current clamp adapter (IT 130)

This function allows the measurement of load currents and leakage currents by means of the optional current clamp adapters BENNING CC 1 and BENNING CC 3 using the TRMS (TRUE RMS) measuring method. This measuring method guarantees correct measuring results even in case of non-sinusoidal signals.

Key function as described in chapter
4.2 Function selector switch

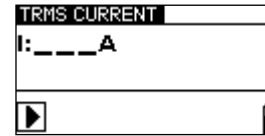

Figure 5.38:
Current

Connection plan

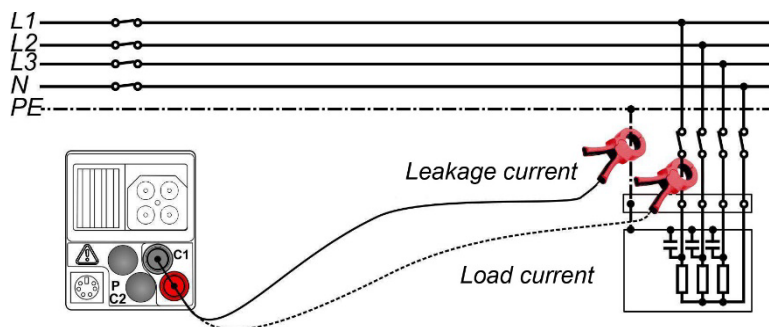

Figure 5.39: Connection of the optional current clamp adapter BENNING CC 1 or BENNING CC 3 - Figure using the IT 130 as an example

How to perform current measurements

- ❑ Set the current clamp adapter as described in chapter 4.4.9 and connect it to measuring input C1.
- ❑ Select the **A** function by means of the function selector switch. The display shows **CURRENT**.
- ❑ Clamp the single-wire conductor by means of the current measuring clamp (see figure 5.39).
- ❑ Press the "TEST" key to start the measurement.
- ❑ Press the "TEST" key again to stop the measurement.
- ❑ Save the measuring result by pressing the "MEM" key (optional for IT 130).

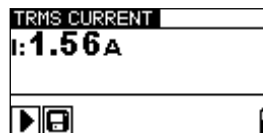

Figure 5.40: Example of a current measurement

Result displayed:

I current

5.10 Single-fault leakage current (ISFL) in IT networks (IT 130)

The IT system is a power supply network which is insulated from the protective conductor. It is an ungrounded power supply network. Either the network is not connected to earth directly or it is connected to earth via a relatively high impedance. It is mainly used in areas requiring additional protection against electrical accidents. A typical area of application are medical operating rooms.

A first insulation fault between an external conductor and earth represents earthing of this conductor. In this case, there is neither a potential difference between conductive housings and earth nor an electric circuit to the transformer closed via earth.

The measurement of the single-fault leakage current is carried out in order to measure the maximum current which might flow from the tested line (external conductor) to the protective conductor. This current flows through the insulating resistance and the phase-to-earth capacities between the other lines (external conductors) and the protective conductor, if the single fault is applied as short-circuit between the tested line and PE.

Key function as described in chapter
4.2 Function selector switch



Figure 5.41:
 Single-fault leakage current (ISFL)

Testing parameters

Limiting value	Maximum single-fault leakage current [without limits (---), 3.0 mA ÷ 20.0 mA]
-----------------------	---

Connection plan

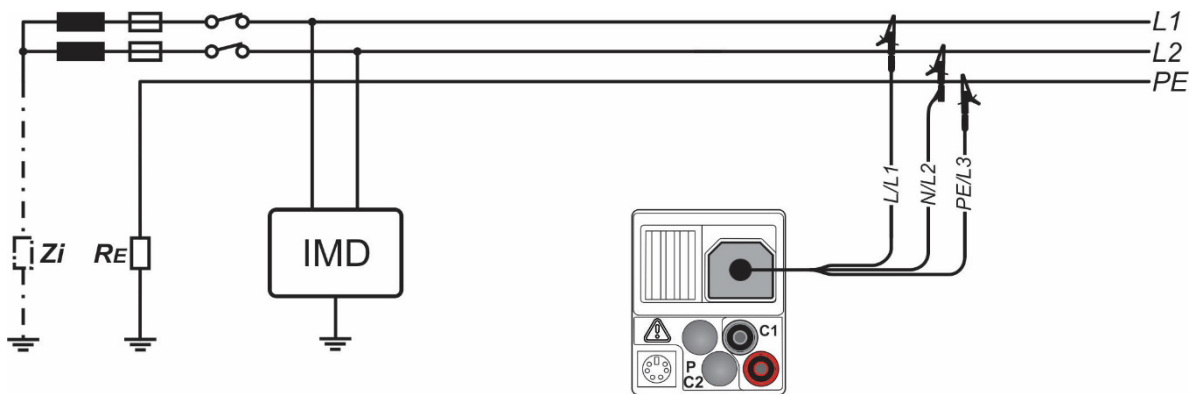

Figure 5.42: Connection of the three-wire test cable - Figure using the IT 130 as an example

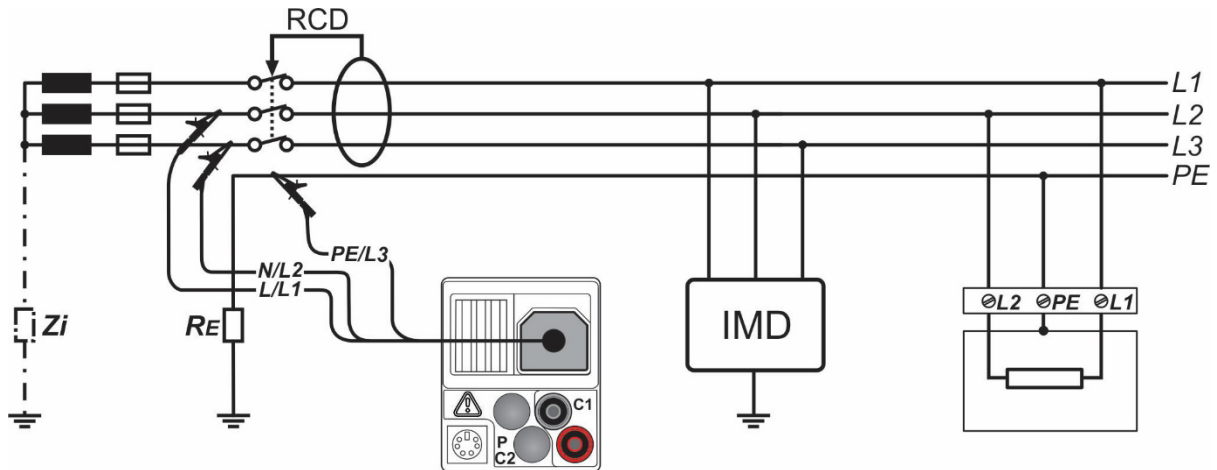

Figure 5.43: Connection of the three-wire test cable in RCD-protected installations
- Figure using the IT 130 as an example

How to perform single-fault leakage current measurements

- Set the earthing system according to chapter 4.4.4 to the IT network type.
- Select the **R_{iso}** function by means of the function selector switch.
- Set the sub-function to **ISFL**.
- Set the limiting value (optional).
- Connect the test cables to the test object (see figure 5.42 and 5.43).
- Press the **"TEST"** key to start the measurement.
- Save the measuring result by pressing the **"MEM"** key (optional for IT 130).



Figure 5.44: Examples of single-fault leakage current measurements

Results displayed:

- Isc1** single-fault leakage current at single fault (earth fault) between L1 and protective conductor (PE)
- Isc2** single-fault leakage current at single fault (earth fault) between L2 and protective conductor (PE)

5.11 Luminous intensity (IT 130)

Luminous intensity measurement can be used for the planning and installation of interior and exterior lighting systems. The optional BENNING luxmeter type B (044111) is connected to the RS232 interface.

Key function as described in chapter 4.2 Function selector switch

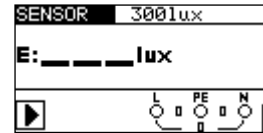

Figure 5.45: Luminous intensity

Testing parameters

Limiting value	Minimum illumination [without limits (---), 0.1 lux ÷ 20 klux]
-----------------------	--

Sensor positioning

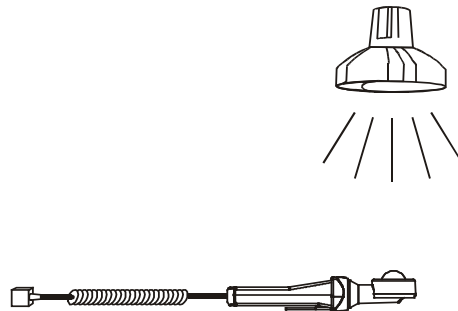

Figure 5.46: Positioning of the luxmeter

How to perform luminous intensity measurements

- ❑ Select the **LUX** function by means of the function selector switch. The display shows **SENSOR**.
- ❑ Set the limiting value (optional).
- ❑ Connect the luxmeter to the PS/2 port of the device.
- ❑ Switch the luxmeter on and position it underneath the light source (see figure 5.46).
- ❑ Press the "**TEST**" key to start the measurement.
- ❑ Save the measuring result by pressing the "**MEM**" key (optional for IT 130).

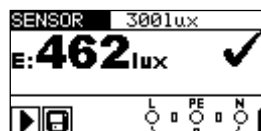

Figure 5.47: Example of a luminous intensity measurement

Result displayed:

E..... luminous intensity

Notes:

- ❑ Shadows and irregular exposure to light might influence the measuring result!
- ❑ Artificial light sources reach their full capacity (see Technical Data of the light sources) only after a certain time and therefore should be switched on until they reach this capacity before carrying out measurements.

6 Management of measured values (IT 130)

6.1 Memory structure (IT 130)

After measurement, the measuring results including all relevant measuring parameters can be stored in the memory of the device.

The memory of the device is divided into four levels with each level offering 199 storage locations. The number of measurements which can be stored in one storage location is not limited.

The installation structure field describes the storage location of the measurement (which object, block, fuse and measuring point) and how it can be accessed.

The measuring result field provides information on the type and number of measurements belonging to the selected storage location (object, block, fuse and measuring point).

RECALL RESULTS
[OBJ]OBJECT 001
[BLK]BLOCK 002
[FUS]FUSE 003
[CON]CONNECTION 004
> No. : 1/36
VOLTAGE TRMS

Figure 6.1: Installation structure field and measuring result field

The memory structure offers the following advantages

- ❑ The measuring results can be structured and stored corresponding to a typical electrical installation.
- ❑ The structure of the electrical system to be tested can be created by means of the logging software BENNING PC-Win IT 130-200 and can be transmitted to the device (upload of installation structures).
- ❑ Easy browsing through installation structures and corresponding measuring results
- ❑ Easy test reports and test protocols can be created by means of the logging software BENNING PC-Win IT 130-200 after the measuring results have been downloaded to a PC.

Installation structure field

RECALL RESULTS	Memory menu
[OBJ]OBJECT 001 [BLK]BLOCK 002 [FUS]FUSE 003 [CON]CONNECTION 004	Installation structure field
[OBJ]OBJECT 001	1st level: OBJECT: Default name of the storage location 001: No. of the storage location
[BLK]BLOCK 002	2nd level: BLOCK: Default name of the storage location 002: No. of the storage location
[FUS]FUSE 003	3rd level: FUSE: Default name of the storage location 003: No. of the storage location
[CON]CONNECTION 004	4th level: CONNECTION (measuring point): Default name of the storage location 004: No. of the storage location
No. : 20 [132]	Number of measurements stored in the selected storage location

	[number of measurements stored in the selected storage location and in subordinate storage locations]
Measuring result field	
VOLTAGE TRMS	Type of measurement stored in the selected storage location
No.: 1/36	No. of the selected measurement / number of all measurements for each storage location

Example of a typical installation structure in the device:

[OBJ] OBJECT 001
[BLO] BLOCK 001
[FUS] FUSE 001
[CON] MEASURING POINT 001
No.: 1/3
R ISO

Example of a customer-specific installation structure in the device:

[OBJ] Customer Meyer
[BLO] Distributor of ground floor
[FUS] F1 kitchen
[CON] Socket 1
No.: 1/3
R ISO

Note:

The customer-specific installation structure has been created by means of the BENNING PC-Win IT 130-200 logging software and then downloaded to the device. Once created, installation structures can be stored in the BENNING PC-Win IT 130-200 logging software and transmitted once again to the device for periodic testing.

6.2 Saving measuring results (IT 130)

After measurement, the measuring results and the corresponding parameters can be saved ( icon appears on the LC display). Press the "**MEM**" key to enter the memory menu.

```

Save results
[OB]OBJECT 002
[BLO]BLOCK 003
[FUS]FUSE 004
> [CON]CONNECTION 005
MEM : SAVE    FREE:96.3%
    
```

Figure 6.2: Memory menu

FREE: 96.3%

Free memory capacity for saving measuring results

Keys used in the installation structure field:

TAB	Selects the storage location (object / block / fuse / measuring point)
UP / DOWN	Selects the no. of the selected storage location (1 to 199)
MEM	Saves the measuring results to the selected storage location
ESC / TEST / function selector switch	Back / cancel without saving

Notes:

- ❑ The device automatically suggests the last selected storage location for saving a new measuring result.
- ❑ If you want to save the measuring result to the same storage location as the previous one, press the "**MEM**" key twice.

6.3 Recalling measuring results (IT 130)

Press the "MEM" key, if there is no measuring result for saving yet, or select "MEMORY", "RECALL RESULTS" in the "SETTINGS" menu.

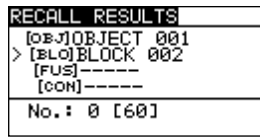

Figure 6.3:

Recall memory menu
– installation structure field selected

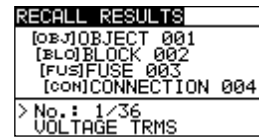

Figure 6.4:

Recall memory menu
– measuring result field selected

Keys used in the installation structure field:

TAB	Selects the storage location (object / block / fuse / measuring point)
UP / DOWN	Selects the no. of the selected storage location (1 to 199)
ESC / function selector switch	Back / cancel to the selected measuring function
TEST / MEM	Selects the corresponding measuring result field

Keys used in the measuring result field:

UP / DOWN	Selects the measurement stored
ESC / TAB	Back / cancel to the installation structure field
Function selector switch	Back / cancel to the selected measuring function
TEST / MEM	Recalls the selected measuring results

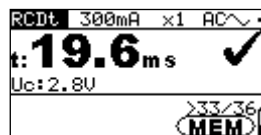

Figure 6.5: Recall of measuring results stored

Keys used in the measuring result field (measuring results are displayed)

UP / DOWN	Recalls measuring results stored in the selected storage location
MEM / ESC	Back / cancel to the measuring result field
TEST	Back / cancel to the installation structure field
Function selector switch	Back / cancel to the selected measuring function

6.4 Deleting measuring results (IT 130)

6.4.1 Deleting the entire measured value memory (IT 130)

Select the **SETTINGS** mode by means of the function selector switch.

Select **"CLEAR ALL MEMORY"** in the **"MEMORY"** menu. The following warning will be displayed:

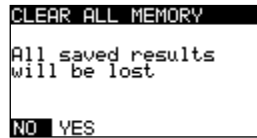

Figure 6.6: Clear all memory

Keys used:

UP / DOWN	Toggles between NO and YES
TEST	Confirms deleting the entire measured value memory
ESC / function selector switch	Back / cancel to the "MEMORY" menu

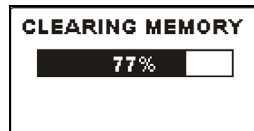

Figure 6.7: Deleting the measured value memory

6.4.2 Deleting all measurements of each storage location and subordinate storage locations

Select the **SETTINGS** mode by means of the function selector switch.

Select **"DELETE RESULTS"** in the **"MEMORY"** menu.

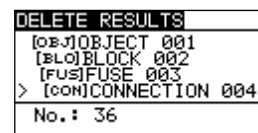
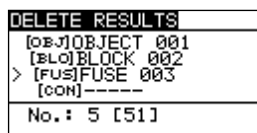

Figure 6.8: Deleting all measurements of each storage location and subordinate storage locations

Keys used in the installation structure field:

TAB	Selects the storage location (object / block / fuse / measuring point)
UP / DOWN	Selects the no. of the selected storage location (1 to 199)
Function selector switch	Back / cancel to the selected measuring function
ESC	Back / cancel to the "MEMORY" menu
TEST	Enters a dialog box for deleting all measurements of the selected storage location and its subordinate storage locations. Press the key again to delete all measurements of this storage location and its subordinate storage locations.

6.4.3 Deleting an individual measurement (IT 130)

Select the **SETTINGS** mode by means of the function selector switch.
 Select "DELETE RESULTS" in the "MEMORY" menu.

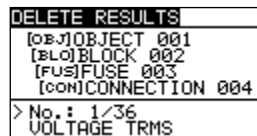

Figure 6.9: Deleting an individual measurement (installation structure field selected)

Keys used in the installation structure field:

TAB	Selects the storage location (object / block / fuse / measuring point)
UP / DOWN	Selects the no. of the selected storage location (1 to 199)
Function selector switch	Back / cancel to the selected measuring function
ESC	Back / cancel to the "MEMORY" menu
MEM	Enters the measuring result field of individual measurements

Keys used in the measuring result field:

UP / DOWN	Selects an individual measurement
TEST	Enters a dialog box for deleting an individual measurement. Press the key again to delete the individual measurement.
TAB / ESC	Back / cancel to the installation structure field
Function selector switch	Back / cancel to the selected measuring function



Figure 6.10:
Deleting an individual measurement

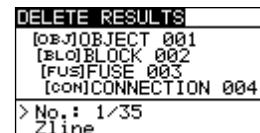

Figure 6.11:
Display after the measurement has been deleted

6.5 Renaming installation structure fields (IT 130)

6.5.1 Renaming installation structure fields by means of the logging software BENNING PC-Win IT 130-200 (IT 130)

The default installation structure field of the device are "Object", "Block", "Fuse" and "Measuring point (CON)".

In the BENNING PC-Win IT 130-200 logging software, the default installation structure field can be renamed with customer-specific names and can be adapted to the installation to be tested. Once created, the installation structures can be stored in the logging software and transmitted to the DEVICE device. Please refer to the help menu of the logging software for further information on how to transmit customer-specific installation structures to the device.

RECALL RESULTS
[OBJ]APPARTMENT1
[BLK]MAIN-BOARD
> [FUS]KITCHEN
No. : 72

Figure 6.12: Example of a customer-specific installation structure

6.5.2 Renaming the installation structure fields by means of the barcode scanner (IT 130)

The default installation structure field of the device are "Object", "Block", "Fuse" and "Measuring point (CON)".

If the device is in the **"SAVE RESULTS"** menu, the identification no. or the designation of the measuring point can be scanned by means of a barcode scanner.

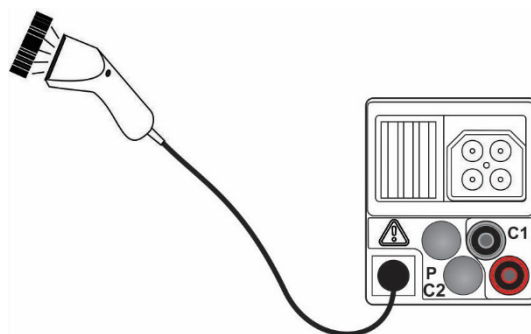

Figure 6.13: Connection of the optional barcode scanner (009371) - Figure using the IT 130 as an example

Renaming the storage location

- Connect the optional barcode scanner to the device.
- Carry out the measurement, press the **"MEM"** key and select the storage location to be renamed in the **"SAVE RESULTS"** menu.
- Scan the identification no. or the designation of the measuring point from the barcode label in order to rename the installation structure field. The device confirms the receipt by two short acoustic signals and displays the identification no. or the designation of the measuring point.

Note:

- Please use barcode scanners only which have been approved by BENNING.

6.6 USB and RS232 interface (IT 130)

The device is provided with the two communication interfaces USB and RS 232. The transmission mode is selected automatically by the device depending on the interface used. Here, the USB interface is given priority.

The stored measuring results can be transmitted to a PC by means of the BENNING PC-Win IT 130-200 logging software. The PC software automatically recognizes the device and thus allows data transmission between the device and the PC.

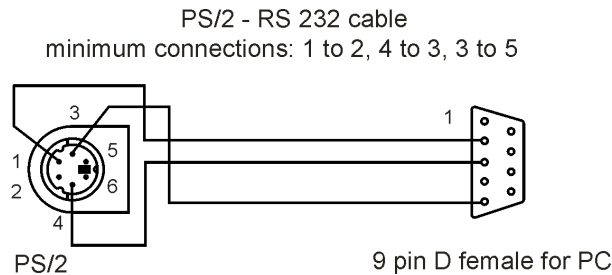

Figure 6.14: Pin assignment of the serial RS232 cable

How to set up a USB or RS232 connection

- ❑ RS232 interface: Connect the serial PS/2-RS232 interface cable to a COM port of the PC and to the PS/2 connector of the device.
- ❑ USB interface: Connect the USB cable to a USB port of the PC and to the USB port of the device.
- ❑ Switch on both the PC and the device.
- ❑ Start the BENNING PC-Win IT 130-200 program.
- ❑ The PC and the device automatically recognize each other.
- ❑ The device is prepared for communication with a PC.

7 Logging software BENNING PC-Win IT 130-200 (IT 130)

The logging software BENNING PC-Win IT 130-200 allows the comfortable management of the measurement data stored by the device. The software is designed for an optimal use of the device BENNING IT 200.

When using the device, the software has limited use and is reduced to functions supported by the device.

Before installation check your system for the following requirements:

- Supported operating systems: Windows 10, 32 bit and 64 bit
- Installed system memory (RAM): at least 2 GB (4 GB recommended)
- Hard disk space:
 - At least 400 MB free space for the installation files and documentation.
 - An additional 280 MB (x86) or 610 MB (x64) of free disk space is required if Microsoft.NET Framework (4.0 or higher) is not installed.
 - Additional disk space (20 GB recommended) for data storage

The latest version of the logging software BENNING PC-Win IT 130-200 is available for free download on the product website of the DEVICE.

<http://tms.benning.de/it130>

To install the software, run the installation file Setup.exe after downloading. After selecting the language, the installation wizard guides you through the installation of the software.

To familiarise yourself with the logging software, use the included help function, which opens an operating manual for the protocol software in PDF format.

For a secure data exchange between the logging software and the device, please use the enclosed USB interface cable.

8 Firmware update

To keep the device up to date, the firmware can be updated from a PC via the RS232-PS/2 interface cable (10008313 optional for 115) included in the scope of delivery.

The latest version of the firmware is available for free download on the product website of the device.

<http://tms.benning.de/it115>

<http://tms.benning.de/it130>

The update process is carried out via the update software FlashMe, which guides through the update process in English.

Note:

It is recommended to have the firmware updated by BENNING Service during calibration (see chapter 9.3 Calibration). Before calibration, the latest firmware is always installed on the device.

9 Maintenance

Unauthorized persons are not allowed to open the device. The device does not contain any replaceable components except for the batteries / storage batteries and the fuse F1.

9.1 Fuse F1 replacement

Three fuses are located behind the rear cover of the device. Only the fuse F1 can be replaced. If one of the fuses F2 or F3 has blown, the device must not be used anymore. In this case, the device must be sent to BENNING for inspection and repair.

❑ **F1**

M 0.315 A / 250 V, 20×5 mm (757211)

This fuse is intended to protect the internal switching circuits for low-impedance measurement / continuity test, if during measurement the test probes are accidentally connected to the mains voltage.

Please refer to chapter 3.3 "*Rear panel*" for information on the position of the fuse F1.

Warnings:

- ❑ Disconnect all test cables and switch off the device before opening the battery / fuse compartment, as dangerous voltages are applied to the device!
- ❑ Replace the defective fuse by original fuses only, because otherwise the device or the accessories might get damaged and / or the operator's safety might be impaired!

9.2 Cleaning

The housing does not require any specific maintenance. Clean the surface of the device or the accessories by means of a soft cloth slightly moistened with soap water or alcohol. After cleaning, let the device or accessories dry completely before using them.

Warnings:

- ❑ Do not use any liquids based on benzine or hydrocarbons!
- ❑ Do not spill any cleaning liquids on the device!

9.3 Calibration

Benning guarantees compliance with this technical and accuracy specifications stated in this operating manual for the first 12 months after the delivery date. To maintain accuracy of the measuring results, make sure that the device is recalibrated in annual intervals by the BENNING Service (chapter 9.4 Service & support).

As part of the calibration, the device is provided with the latest firmware update and thus always remains up to date.

<http://calibration.benning.de>



9.4 Service & support

Please contact your specialty retailer or the BENNING Service Center for any repair or service work that might be required.

Technical support

Please contact our Technical support for technical questions on handling the device.

Phone: +49 2871 93-555

Fax: +49 2871 93-6555

E-mail: helpdesk@benning.de

Internet: www.benning.de

Returns management

Easily and conveniently use the BENNING returns portal for a quick and smooth returns processing:

<https://www.benning.de/service-de/retourenabwicklung.html>

Phone: +49 2871 93-554

E-mail: returns@benning.de

Return address

BENNING Elektrotechnik und Elektronik GmbH & Co. KG

Retourenmanagement

Robert-Bosch-Str. 20

D - 46397 Bocholt

Additional product information can be found on our website. www.benning.de

9.5 Disposal and environmental protection



At the end of product life, dispose of the unserviceable device and the batteries via appropriate collecting facilities provided in your community.

10 Technical data

10.1 Insulating resistance

Insulating resistance (nominal voltages of 50 V_{DC}, 100 V_{DC} and 250 V_{DC})

Measuring range according to EN 61557-2: 0.15 MΩ ÷ 199.9 MΩ

Measuring range (MΩ)	Resolution (MΩ)	Accuracy
0.00 ÷ 19.99	0.01	±(5 % of the measured value + 3 digits)
20.0 ÷ 99.9	0.1	±(10 % of the measured value)
100.0 ÷ 199.9		±(20 % of the measured value)

Insulating resistance (nominal voltages of 500 V_{DC} and 1000 V_{DC})

Measuring range according to EN 61557-2: 0.15 MΩ ÷ 999 MΩ

Measuring range (MΩ)	Resolution (MΩ)	Accuracy
0.00 ÷ 19.99	0.01	±(5 % of the measured value + 3 digits)
20.0 ÷ 199.9	0.1	±(5 % of the measured value)
200 ÷ 999	1	±(10 % of the measured value)

Voltage

Measuring range (V)	Resolution (V)	Accuracy
0 ÷ 1200	1	±(3 % of the measured value + 3 digits)

Nominal voltages 50 V_{DC}, 100 V_{DC}, 250 V_{DC}, 500 V_{DC}, 1000 V_{DC}

Open-circuit voltage -0 % / +20 % of the nominal voltage

Measuring current min. 1 mA at R_N=U_N×1 kΩ/V

Short-circuit current max. 3 mA

Number of possible tests > 1200, with fully charged battery / storage battery

Automatic discharge after test.

The accuracy specified shall apply for the use of the three-wire test cable and shall apply up to 100 MΩ for the use of the "Commander" test probe.

The accuracy specified shall apply up to 100 MΩ for a relative air humidity > 85 %.

If the device gets wet, the results might be affected. In this case, it is recommended to let the device and its accessories dry for at least 24 hours.

The maximum error under operating conditions corresponds to the maximum error under reference conditions ± 5 % of the measured value.

10.2 Low-impedance resistance / continuity test

10.2.1 Low-impedance resistance R LOW

Measuring range according to EN 61557-4: 0.16 Ω ÷ 1999 Ω

Measuring range R (Ω)	Resolution (Ω)	Accuracy
0.00 ÷ 19.99	0.01	$\pm(3\%$ of the measured value + 3 digits)
20.0 ÷ 199.9	0.1	$\pm(5\%$ of the measured value)
200 ÷ 1999	1	

Measuring range R+, R- (Ω)	Resolution (Ω)	Accuracy
0.0 ÷ 199.9	0.1	$\pm(5\%$ of the measured value + 5 digits)
200 ÷ 1999	1	

Open-circuit voltage6.5 V DC ÷ 9 V DC

Measuring current.....min. 200 mA for a load resistance of 2 Ω

Test cable compensation.....up to 5 Ω

Number of possible tests> 2000, with fully charged batteries / storage batteries

Automatic polarity reversal of the testing voltage.

10.2.2 Continuity test

Measuring range (Ω)	Resolution (Ω)	Accuracy
0.0 ÷ 19.9	0.1	$\pm(5\%$ of the measured value + 3 digits)
20 ÷ 1999	1	

Open-circuit voltage6.5 V DC ÷ 9 V DC

Short-circuit currentmax. 8.5 mA

Test cable compensation.....up to 5 Ω

10.3 Residual current protection devices (RCDs)

10.3.1 General data (IT 115)

Nominal tripping differential current 10 mA, 30 mA, 100 mA, 300 mA, 500 mA, 1000 mA

Accuracy.....-0 / +0, 1· I_{Δ} ; $I_{\Delta} = I_{\Delta N}$, 2× $I_{\Delta N}$, 5× $I_{\Delta N}$

-0.1· I_{Δ} / +0; $I_{\Delta} = 0.5 \times I_{\Delta N}$

AS / NZS: $\pm 5\%$

Shape of testing current.....sinusoidal (type AC), pulsating (type A, type F)

DC offset for pulsating testing current.....6 mA (typical)

RCD type.....undelayed, delayed (S)

Initial polarity of the testing current 0° or 180°

Voltage range93 V ÷ 134 V (45 Hz ÷ 65 Hz)

185 V ÷ 266 V (45 Hz ÷ 65 Hz)

Current selection for RCD testing (r.m.s. value calculated for 20 ms) according to IEC 61009:

$I_{\Delta N}$ (mA)	$I_{\Delta N} \times 1/2$		$I_{\Delta N} \times 1$		$I_{\Delta N} \times 2$		$I_{\Delta N} \times 5$		RCD I_{Δ}	
	AC	A, F	AC	A, F	AC	A, F	AC	A, F	AC	A, F
10	5	3,5	10	20	20	40	50	100	✓	✓
30	15	10,5	30	42	60	84	150	212	✓	✓
100	50	35	100	141	200	282	500	707	✓	✓
300	150	105	300	424	600	848	1500	-	✓	✓
500	250	175	500	707	1000	1410	2500	-	✓	✓
1000	500	350	1000	1410	2000	-	-	-	✓	✓

„-“not applicable
 Type ACsinusoidal testing current
 Type A, type Fpulsating testing current

10.3.2 General data (IT 130)

Nominal tripping differential current (A, AC).. 10 mA, 30 mA, 100 mA, 300 mA, 500 mA, 1000 mA

Nominal tripping differential current (EV, MI) 30 mA AC, 6 mA DC

Accuracy..... -0 / +0,1· I_{Δ} ; $I_{\Delta} = I_{\Delta N}$, 2· $I_{\Delta N}$, 5· $I_{\Delta N}$
 -0.1· I_{Δ} / +0; $I_{\Delta} = 0.5 \times I_{\Delta N}$
 AS / NZS: $\pm 5\%$

Shape of testing current..... sinusoidal (type AC, type EV/MI [AC part]),
 pulsating (type A, type F),
 smooth direct current (type B, type B+,
 type EV/MI [DC part]),

DC offset for pulsating testing current..... 6 mA (typical)
 RCD type..... undelayed, delayed (S)
 Initial polarity of the testing current 0° or 180°

Voltage range 93 V ÷ 134 V (45 Hz ÷ 65 Hz)
 185 V ÷ 266 V (45 Hz ÷ 65 Hz)

Current selection for RCD testing (r.m.s. value calculated for 20 ms) according to IEC 61009:

$I_{\Delta N}$ (mA)	$I_{\Delta N} \times 1/2$			$I_{\Delta N} \times 1$			$I_{\Delta N} \times 2$			$I_{\Delta N} \times 5$			RCD I_{Δ}		
	AC	A, F	B, B+	AC	A, F	B, B+	AC	A, F	B, B+	AC	A, F	B, B+	AC	A, F	B, B+
10	5	3,5	5	10	20	20	20	40	40	50	100	100	✓	✓	✓
30	15	10,5	15	30	42	60	60	84	120	150	212	300	✓	✓	✓
100	50	35	50	100	141	200	200	282	400	500	707	1000	✓	✓	✓
300	150	105	150	300	424	600	600	848	-	1500	-	-	✓	✓	✓
500	250	175	250	500	707	1000	1000	1410	-	2500	-	-	✓	✓	✓
1000	500	350	500	1000	1410	-	2000	-	-	-	-	-	✓	✓	-

“✓”applicable
 “-”not applicable
 Type ACsinusoidal testing current
 Type A, type Fpulsating testing current
 Type B, type B+testing current is a smooth direct current

$I_{\Delta N}$ (mA)	$I_{\Delta N} \times 1/2$	$I_{\Delta N} \times 1$	$I_{\Delta N} \times 2$	$I_{\Delta N} \times 5$	RCD I_{Δ}	
	EV/MI (AC part)	EV/MI (AC part)	EV/MI (AC part)	EV/MI (AC part)	EV/MI (AC part)	EV/MI (DC part)
30 AC	15	30	60	150	✓	-
6 DC	-	6	-	-	-	✓

“-”not applicable

Type EV, MI (AC part)sinusoidal testing current

Type EV, MI (DC part)testing current is a smooth direct current

10.3.3 Contact voltage (U_c)

Measuring range according to EN 61557-6: 20.0 V ÷ 31.0 V for limiting value of 25 V

Measuring range according to EN 61557-6: 20.0 V ÷ 62.0 V for limiting value of 50 V

Measuring range (V)	Resolution (V)	Accuracy
0.0 ÷ 19.9	0.1	(-0 % / +15 %) of the measured value ± 10 digits
20.0 ÷ 99.9	0.1	(-0 % / +15 %) of the measured value

The specified accuracy shall apply for stable mains voltages and protective conductor connections without any interference voltages.

Testing current..... max. $0.5 \times I_{\Delta N}$

Limiting value for contact voltage..... 25 V, 50 V

The specified accuracy shall apply to the entire measuring range.

10.3.4 Tripping time (RCD t)

The entire measuring range complies with the requirements specified in the EN 61557-6 standard.

Measuring range*	Resolution (ms)	Accuracy
0.0 ÷ 999.9 ms	0.1	±3 ms
1.0 ÷ 10.0 s	10	±10 ms

* The maximum measuring duration depends on the RCD testing standard selected (see chapter 4.4.5 RCD testing).

Testing current..... $\frac{1}{2} \times I_{\Delta N}$, $I_{\Delta N}$, $2 \times I_{\Delta N}$, $5 \times I_{\Delta N}$

$5 \times I_{\Delta N}$ is not available for $I_{\Delta N}=1000$ mA (RCD type AC) or $I_{\Delta N} \geq 300$ mA (RCD type A, type F).

$2 \times I_{\Delta N}$ is not available for $I_{\Delta N}=1000$ mA (RCD type A, type F).

The specified accuracy shall apply to the entire measuring range.

10.3.5 Tripping current (RCD I) (IT 115)

Tripping current

Standard EN 60364-4-41 (VDE 0100-410), (SETTINGS --> RCD/FI test):

The entire measuring range complies with the requirements specified in the EN 61557-6 standard.

Measuring range I_{Δ}	Resolution I_{Δ}	Accuracy
$0.1 \times I_{\Delta N} \div 1.1 \times I_{\Delta N}$ (type AC)	$0.05 \times I_{\Delta N}$	$\pm 0.1 \times I_{\Delta N}$
$0.1 \times I_{\Delta N} \div 1.5 \times I_{\Delta N}$ (type A, $I_{\Delta N} \geq 30$ mA)	$0.05 \times I_{\Delta N}$	$\pm 0.1 \times I_{\Delta N}$
$0.1 \times I_{\Delta N} \div 2.2 \times I_{\Delta N}$ (type A, $I_{\Delta N} \geq 30$ mA)	$0.05 \times I_{\Delta N}$	$\pm 0.1 \times I_{\Delta N}$

Standard EN 61008/EN 61009 (VDE 0664-10/VDE 0664-20), (SETTINGS --> RCD/FI test):

The entire measuring range complies with the requirements specified in the EN 61557-6 standard.

Measuring range I_{Δ}	Resolution I_{Δ}	Accuracy
$0.2 \times I_{\Delta N} \div 1.1 \times I_{\Delta N}$ (type AC)	$0.05 \times I_{\Delta N}$	$\pm 0.1 \times I_{\Delta N}$
$0.2 \times I_{\Delta N} \div 1.5 \times I_{\Delta N}$ (type A, $I_{\Delta N} \geq 30$ mA)	$0.05 \times I_{\Delta N}$	$\pm 0.1 \times I_{\Delta N}$
$0.2 \times I_{\Delta N} \div 2.2 \times I_{\Delta N}$ (type A, $I_{\Delta N} \geq 30$ mA)	$0.05 \times I_{\Delta N}$	$\pm 0.1 \times I_{\Delta N}$

Tripping time

Measuring range (ms)	Resolution (ms)	Accuracy
0 ÷ 300	1	± 3 ms

Contact voltage

Measuring range (V)	Resolution (V)	Accuracy
0.0 ÷ 19.9	0.1	(-0 % / +15 %) of the measured value ± 10 digits
20.0 ÷ 99.9	0.1	(-0 % / +15 %) of the measured value

The specified accuracy shall apply for stable mains voltages and protective conductor connections without any interference voltages.

The specified accuracy shall apply to the entire measuring range.

10.3.6 Tripping current (RCD I) (IT 130)

Tripping current

Norm EN 60364-4-41, (SETTINGS: → RCD TESTING):

The entire measuring range complies with the requirements specified in the EN 61557-6 standard.

Measuring range I_{Δ}	Resolution I_{Δ}	Accuracy
$0.1 \times I_{\Delta N} \div 1.1 \times I_{\Delta N}$ (type AC, EV/MI AC part)	$0.05 \times I_{\Delta N}$	$\pm 0.1 \times I_{\Delta N}$
$0.1 \times I_{\Delta N} \div 1.5 \times I_{\Delta N}$ (type A, F, $I_{\Delta N} \geq 30$ mA)	$0.05 \times I_{\Delta N}$	$\pm 0.1 \times I_{\Delta N}$
$0.1 \times I_{\Delta N} \div 2.2 \times I_{\Delta N}$ (type A, F, $I_{\Delta N} < 30$ mA)	$0.05 \times I_{\Delta N}$	$\pm 0.1 \times I_{\Delta N}$
$0.1 \times I_{\Delta N} \div 2.2 \times I_{\Delta N}$ (type B, MI DC part)	$0.05 \times I_{\Delta N}$	$\pm 0.1 \times I_{\Delta N}$
$0.1 \times I_{\Delta N} \div 1.0 \times I_{\Delta N}$ (type EV DC part)	$0.05 \times I_{\Delta N}$	$\pm 0.1 \times I_{\Delta N}$

Norm EN 61008/EN 61009, (SETTINGS: → RCD TESTING):

The entire measuring range complies with the requirements specified in the EN 61557-6 standard.

Measuring range I_{Δ}	Resolution I_{Δ}	Accuracy
$0.2 \times I_{\Delta N} \div 1.1 \times I_{\Delta N}$ (type AC, EV/MI AC part)	$0.05 \times I_{\Delta N}$	$\pm 0.1 \times I_{\Delta N}$
$0.2 \times I_{\Delta N} \div 1.5 \times I_{\Delta N}$ (type A, F, $I_{\Delta N} \geq 30$ mA)	$0.05 \times I_{\Delta N}$	$\pm 0.1 \times I_{\Delta N}$
$0.2 \times I_{\Delta N} \div 2.2 \times I_{\Delta N}$ (type A, F, $I_{\Delta N} < 30$ mA)	$0.05 \times I_{\Delta N}$	$\pm 0.1 \times I_{\Delta N}$
$0.2 \times I_{\Delta N} \div 2.2 \times I_{\Delta N}$ (type B, B+, MI DC part)	$0.05 \times I_{\Delta N}$	$\pm 0.1 \times I_{\Delta N}$
$0.2 \times I_{\Delta N} \div 1.0 \times I_{\Delta N}$ (type EV DC part)	$0.05 \times I_{\Delta N}$	$\pm 0.1 \times I_{\Delta N}$

Tripping time

Measuring range	Resolution (ms)	Accuracy
0 ÷ 999.9 ms	0.1	±3 ms
1.0 ÷ 10.0 s	10	±10 ms

Contact voltage

Measuring range (V)	Resolution (V)	Accuracy
0.0 ÷ 19.9	0.1	(-0 % / +15 %) of the measured value ± 10 digits
20.0 ÷ 99.9	0.1	(-0 % / +15 %) of the measured value

The specified accuracy shall apply for stable mains voltages and protective conductor connections without any interference voltages.

Tripping current measurement is not available for $I_{\Delta N}=1000$ mA (RCD type B, type B+).

The specified accuracy shall apply to the entire measuring range.

Tripping current limits

RCD type	Tripping current	
	Lower limit	Upper limit
		$I_{\Delta N} < 30$ mA
AC (sinusoidal)	$0.5 \times I_{\Delta N}$	$I_{\Delta N}$
A, F (pulsating)	$0.35 \times I_{\Delta N}$	$2 \times I_{\Delta N}$ $1.4 \times I_{\Delta N}$
B, B+, MI (DC)	$0.5 \times I_{\Delta N}$	$2 \times I_{\Delta N}$
EV (DC)	$0.1 \times I_{\Delta N}$	6 mA

Note:

If the **EN 60364-4-41** standard has been selected (SETTINGS: → RCD testing), a tripping current of less than the lower limit will be displayed without any evaluation (~~x~~ / ✓).

10.4 Loop impedance and prospective short-circuit current

10.4.1 Zs function (for systems without RCD)

Loop impedance

Measuring range according to EN 61557-3: 0.25 Ω ÷ 9.99 k Ω

Measuring range (Ω)	Resolution (Ω)	Accuracy
0.00 ÷ 9.99	0.01	± (5 % of the measured value + 5 digits)
10.0 ÷ 99.9	0.1	
100 ÷ 999	1	±10 % of the measured value
1.00 k ÷ 9.99 k	10	

Prospective short-circuit current (calculated value)

Measuring range (A)	Resolution (A)	Accuracy
0.00 ÷ 9.99	0.01	Please observe the accuracy of the loop resistance measurement.
10.0 ÷ 99.9	0.1	
100 ÷ 999	1	
1.00 k ÷ 9.99 k	10	
10.0 k ÷ 23.0 k	100	

The accuracy specified shall apply provided that the mains voltage is stable during measurement.

Testing current (at 230 V) 6.5 A (10 ms)

Nominal voltage range 93 V ÷ 134 V (45 Hz ÷ 65 Hz)

185 V ÷ 266 V (45 Hz ÷ 65 Hz)

10.4.2 Zsrcd function (for systems with RCD)

Loop impedance

Measuring range according to EN 61557-3: 0.46 Ω ÷ 9.99 k Ω

Measuring range (Ω)	Resolution (Ω)	Accuracy
0.00 ÷ 9.99	0.01	±(5 % of the measured value + 10 digits)
10.0 ÷ 99.9	0.1	
100 ÷ 999	1	±10 % of the measured value
1.00 k ÷ 9.99 k	10	

Accuracy might be impaired due to interference voltages in the mains voltage.

Prospective short-circuit current (calculated value)

Measuring range (A)	Resolution (A)	Accuracy
0.00 ÷ 9.99	0.01	Please observe the accuracy of the loop impedance measurement.
10.0 ÷ 99.9	0.1	
100 ÷ 999	1	
1.00 k ÷ 9.99 k	10	
10.0 k ÷ 23.0 k	100	

Nominal voltage range 93 V ÷ 134 V (45 Hz ÷ 65 Hz)

185 V ÷ 266 V (45 Hz ÷ 65 Hz)

No tripping of the residual current protection device (RCD).

10.5 Line impedance and prospective short-circuit current / voltage drop

Line impedance

Measuring range according to EN 61557-3: 0.25 Ω \div 9.99 k Ω

Measuring range (Ω)	Resolution (Ω)	Accuracy
0.00 \div 9.99	0.01	\pm (5 % of the measured value + 5 digits)
10.0 \div 99.9	0.1	
100 \div 999	1	\pm 10 % of the measured value
1.00 k \div 9.99 k	10	

Prospective short-circuit current (calculated value)

Measuring range (A)	Resolution (A)	Accuracy
0.00 \div 0.99	0.01	Please observe the accuracy of the line impedance measurement.
1.0 \div 99.9	0.1	
100 \div 999	1	
1.00 k \div 99.99 k	10	
100 k \div 199 k	1000	

Testing current (at 230 V) 6.5 A (10 ms)
 Nominal voltage range 93 V \div 134 V (45 Hz \div 65 Hz)
 185 V \div 266 V (45 Hz \div 65 Hz)
 321 V \div 485 V (45 Hz \div 65 Hz)

Voltage drop (calculated value)

Measuring range (%)	Resolution (%)	Accuracy
0.0 \div 99.9	0.1	Please observe the accuracy of the line impedance measurement*.

Z_{REF} measuring range0.00 Ω \div 20.0 Ω

* Please refer to chapter 5.6.2 *Voltage drop* for information on how to calculate the voltage drop.

10.6 Earthing resistance

Measuring range according to EN61557-5: 2.00 Ω \div 1999 Ω

Measuring range (Ω)	Resolution (Ω)	Accuracy
0.00 \div 19.99	0.01	\pm (5 % of the measured value + 5 digits)
20.0 \div 199.9	0.1	
200 \div 9999	1	

Maximum auxiliary earth electrode resistance R_C ... 100 $\times R_E$ or 50 k Ω (the lower value shall apply)
 Maximum probe resistance R_P 100 $\times R_E$ or 50 k Ω (the lower value shall apply)
 Additional error at R_{Cmax} or R_{Pmax} \pm (10 % of the measured value + 10 digits)
 Additional error at interference voltage of 3 V (50 Hz) \pm (5 % of the measured value + 10 digits)
 Open-circuit voltage < 30 VAC
 Short-circuit current < 30 mA
 Frequency of testing voltage 125 Hz, sinusoidal
 Interference voltage indicating threshold 1 V (< 50 Ω , maximum)

Automatic measurement of auxiliary earth electrode resistance and probe resistance.
 Automatic monitoring of interference voltage.

10.7 TRMS voltage, frequency and phase sequence

10.7.1 TRMS voltage (AC/DC)

Measuring range (V)	Resolution (V)	Accuracy
0 ÷ 550	1	± (2 % of the measured value + 2 digits)

Measuring method true r.m.s. value (TRMS)

Frequency range 0 Hz, 14 Hz ÷ 500 Hz

10.7.2 Voltage of the connection monitor

Measuring range (V)	Resolution (V)	Accuracy
10 ÷ 550	1	±(2 % of the measured value + 2 digits)

10.7.3 Frequency

Measuring range (Hz)	Resolution (Hz)	Accuracy
0.00 ÷ 9.99	0.01	±(0.2 % of the measured value + 1 digit)
10.0 ÷ 499.9	0.1	

Voltage range 10 V ÷ 550 V

10.7.4 Phase sequence (rotary field)

Voltage range 100 V_{AC} ÷ 550 V_{AC}

Frequency range 14 Hz ÷ 500 Hz

Result displayed 1.2.3 or 3.2.1

10.8 TRMS current (AC / DC) via current clamp adapter (IT 130)

Measuring input C1 of the device:

Maximum voltage 3 V

Frequency 0 Hz, 40 Hz ÷ 500 Hz

AC current clamp adapter BENNING CC 1 (044037)

Range = 400 A

Output signal 1 mV AC per 1 A AC

Frequency 50 Hz ÷ 60 Hz

Measuring range (A)	Resolution (A)	Accuracy*
0.00 ÷ 0.99	0.01	indicative
1.00 ÷ 19.99	0.01	±(3 % of the measured value + 0.5 A)
20.0 ÷ 349.9	0.1	±(3 % of the measured value + 0.5 A)
350.0 ÷ 399.9	0.1	±(5 % of the measured value + 1 A)

AC / DC current clamp adapter BENNING CC 3 (044038)

Range = 40 A

Output signal 10 mV AC/DC per 1 A AC/DC

Frequency 0 Hz, 40 Hz ÷ 400 Hz

Measuring range (A)	Resolution (A)	Accuracy*
0.00 ÷ 1.99	0.01	±(3 % of the measured value + 0.2 A)
2.00 ÷ 19.99	0.01	±(3 % of the measured value + 0.3 A)
20.0 ÷ 39.9	0.1	±(3 % of the measured value + 0.5 A)

Range = 300 A

Output signal 1 mV AC/DC per 1 A AC/DC

Measuring range (A)	Resolution (A)	Accuracy*
0.00 ÷ 19.99	0.01	indicative
20.0 ÷ 39.9	0.1	
40.0 ÷ 199.9	0.1	±(4 % of the measured value + 1 A)
200.0 ÷ 299.9	0.1	±(4 % of the measured value + 2 A)

* The specified accuracy shall apply to the DEVICE device and the BENNING current clamp adapters used.

10.9 Single-fault leakage current (ISFL) in IT networks (IT 130)

Measuring range (mA)	Resolution (mA)	Accuracy
0.0 ÷ 19.9	0.1	±(5 % of the measured value + 3 digits)

Measuring resistance..... approx. 390 Ω

Voltage ranges 93 V ≤ U_{L1-L2} < 134 V

185 V ≤ U_{L1-L2} ≤ 266 V

10.10 Luminous intensity (IT 130)

The specified accuracy shall apply to the entire measuring range and for the use of the BENNING luxmeter type B (044111).

Measuring range (lux)	Resolution (lux)	Accuracy
0.01 ÷ 19.99	0.01	±(5 % of the measured value)
20.0 ÷ 199.9	0.1	
200 ÷ 1999	1	
2.00 ÷ 19.99 k	10	

Measuring principle silicon photodiode with V(λ) filter

Spectral response error < 3.8 % according to CIE curve

Cosine error..... < 2.5 % up to an angle of incidence of ± 85°

Overall accuracy..... corresponds to DIN 5032, class B standard

10.11 General data

Power supply voltage.....	9 V _{DC} (6×1.5 V batteries or storage batteries, type AA)
Operating time.....	typically 20 h
Input voltage of charging jack.....	12 V ± 10 %
Input current of charging jack.....	max. 400 mA
Storage battery charging current	250 mA (internally regulated)
Measuring category	1000 V CAT II to earth 600 V CAT III to earth 300 V CAT IV to earth
Protection class	double insulation
Contamination level	2
Protection category.....	IP 40
Display	matrix display with 128 x 64 pixels and background lighting
Dimensions (w × h × d).....	23 cm × 10.3 cm × 11.5 cm
Weight	1.3 kg, without batteries / storage batteries
Reference conditions:	
Temperature range.....	+10 °C ÷ +30 °C
Air humidity range.....	40 % rel. Air humidity ÷ 70 % rel. air humidity
Operating conditions:	
Temperature range.....	0 °C ÷ +40 °C
Maximum relative air humidity	95 % rel. air humidity (0 °C ÷ 40 °C), non-condensing
Storage conditions:	
Temperature range.....	-10 °C ÷ +70 °C
Maximum relative air humidity	90 % rel. air humidity (-10 °C ÷ +40 °C) 80 % rel. air humidity (40 °C ÷ 60 °C)
Transmission speed/ baud rate(IT 130):	
RS232 interface.....	57600 baud
USB interface	256000 baud
Memory size (IT 130).....	up to 1800 measurements

The specified accuracy shall apply to the first year of use under reference conditions. If not specified otherwise for the respective measuring function, an additional error of max. + 1 % of the measured value + 1 digit has to be considered for the use under operating conditions.

Appendix A Fuse table – Prospective short-circuit current

A.1 Fuse, type NV

NH: low-voltage high-breaking-capacity fuse

Nominal current [A]	Disconnection time [ms]			
	35	40	70	100
Minimum prospective short-circuit current [A]				
2	32.5	31.8	27.1	22.3
4	65.6	64.2	55.3	46.4
6	102.8	100.3	85.2	70.0
8	140.0	136.4	114.2	92.0
10	165.8	162.0	138.7	115.3
12	190.0	186.0	161.5	137.0
16	206.9	202.6	176.7	150.8
20	276.8	271.3	237.8	204.2
25	361.3	353.4	305.5	257.5
35	618.1	605.5	529.4	453.2
50	919.2	897.8	768.9	640.0
63	1 217.2	1 186.8	1 004.3	821.7
80	1 567.2	1 533.9	1 333.5	1 133.1
100	2 075.3	2 025.6	1 727.3	1 429.0
125	2 826.3	2 763.2	2 384.6	2 006.0
160	3 538.2	3 457.2	2 971.2	2 485.1
200	4 555.5	4 473.5	3 981.0	3 488.5
224	5 500.0	5 384.7	4 692.4	4 000.0
250	6 032.4	5 906.8	5 153.2	4 399.6
315	7 766.8	7 636.1	6 851.4	6 066.6
400	10 577.7	10 374.0	9 151.6	7 929.1
500	13 619.0	13 412.5	12 173.0	10 933.5
630	19 619.3	19 190.0	16 613.7	14 037.4
710	19 712.3	19 562.7	18 664.8	17 766.9
800	25 260.3	24 860.3	22 460.1	20 059.8
1 000	34 402.1	33 567.8	28 561.7	23 555.5
1 250	45 555.1	44 831.9	40 492.3	36 152.6

Nominal current [A]	Disconnection time [s]			
	0.2	0.4	1	5
	Minimum prospective short-circuit current [A]			
2	18.7	15.9	13	9.1
4	38.8	31.9	26	18.7
6	56.5	46.4	38	26.7
8	73.0	60.0	47	33.0
10	96.5	80.7	70	46.4
12	114.0	88.0	80	50.0
16	126.1	107.4	90	66.3
20	170.8	145.5	120	86.7
25	215.4	180.2	148	109.3
35	374.0	308.7	240	169.5
50	545.0	464.2	380	266.9
63	663.3	545.0	440	319.1
80	964.9	836.5	670	447.9
100	1 195.4	1 018.0	830	585.4
125	1 708.3	1 454.8	1 180	765.1
160	2 042.1	1 678.1	1 380	947.9
200	2 970.8	2 529.9	2 050	1 354.5
224	3 300.0	2 700.0	2 150	1 500.0
250	3 615.3	2 918.2	2 300	1 590.6
315	4 985.1	4 096.4	3 300	2 272.9
400	6 632.9	5 450.5	4 300	2 766.1
500	8 825.4	7 515.7	5 750	3 952.7
630	11 534.9	9 310.9	7 400	4 985.1
710	14 341.3	11 996.9	8 760	6 423.2
800	16 192.1	13 545.1	10 800	7 252.1
1 000	19 356.3	16 192.1	13 000	9 146.2
1 250	29 182.1	24 411.6	19 500	13 070.1

A.2 Fuse, utilization category gG

gG: general-purpose fuse for general applications, mainly for cable and line protection

Nominal current [A]	Disconnection time [ms]			
	35	40	70	100
	Minimum prospective short-circuit current [A]			
2	32.5	31.8	27.1	22.3
4	65.6	64.2	55.3	46.4
6	102.8	100.3	85.2	70.0
8	140.0	136.4	114.2	92.0
10	165.8	162.0	138.7	115.3
12	190.0	186.0	161.5	137.0
16	206.9	202.6	176.7	150.8
20	276.8	271.3	237.8	204.2
25	361.3	353.4	305.5	257.5
35	618.1	605.5	529.4	453.2
50	919.2	897.8	768.9	640.0
63	1 217.2	1 186.8	1 004.3	821.7
80	1 567.2	1 533.9	1 333.5	1 133.1
100	2 075.3	2 025.6	1 727.3	1 429.0
125	2 826.3	2 763.2	2 384.6	2 006.0
160	3 538.2	3 457.2	2 971.2	2 485.1
200	4 555.5	4 473.5	3 981.0	3 488.5
224	5 500.0	5 384.7	4 692.4	4 000.0
250	6 032.4	5 906.8	5 153.2	4 399.6
315	7 766.8	7 636.1	6 851.4	6 066.6
400	10 577.7	10 374.0	9 151.6	7 929.1
500	13 619.0	13 412.5	12 173.0	10 933.5
630	19 619.3	19 190.0	16 613.7	14 037.4
710	19 712.3	19 562.7	18 664.8	17 766.9
800	25 260.3	24 860.3	22 460.1	20 059.8
1 000	34 402.1	33 567.8	28 561.7	23 555.5
1 250	45 555.1	44 831.9	40 492.3	36 152.6

Nominal current [A]	Disconnection time [s]			
	0.2	0.4	1	5
	Minimum prospective short-circuit current [A]			
2	18.7	15.9	13	9.1
4	38.8	31.9	26	18.7
6	56.5	46.4	38	26.7
8	73.0	60.0	47	33.0
10	96.5	80.7	70	46.4
12	114.0	88.0	80	50.0
16	126.1	107.4	90	66.3
20	170.8	145.5	120	86.7
25	215.4	180.2	148	109.3
35	374.0	308.7	240	169.5
50	545.0	464.2	380	266.9
63	663.3	545.0	440	319.1
80	964.9	836.5	670	447.9
100	1 195.4	1 018.0	830	585.4
125	1 708.3	1 454.8	1 180	765.1
160	2 042.1	1 678.1	1 380	947.9
200	2 970.8	2 529.9	2 050	1 354.5
224	3 300.0	2 700.0	2 150	1 500.0
250	3 615.3	2 918.2	2 300	1 590.6
315	4 985.1	4 096.4	3 300	2 272.9
400	6 632.9	5 450.5	4 300	2 766.1
500	8 825.4	7 515.7	5 750	3 952.7
630	11 534.9	9 310.9	7 400	4 985.1
710	14 341.3	11 996.9	8 760	6 423.2
800	16 192.1	13 545.1	10 800	7 252.1
1 000	19 356.3	16 192.1	13 000	9 146.2
1 250	29 182.1	24 411.6	19 500	13 070.1

A.3 Line safety switch, tripping characteristic B

Range of instantaneous tripping: $3 - 5 \times I_N$

Nominal current [A]	Disconnection time [s]							
	0.035	0.04	0.07	0.1	0.2	0.4	1	5
	Minimum prospective short-circuit current [A]							
1.6	8	8	8	8	8	8	8	8
2.0	10	10	10	10	10	10	10	10
4.0	20	20	20	20	20	20	20	20
6.0	30	30	30	30	30	30	30	30
8.0	40	40	40	40	40	40	40	40
10.0	50	50	50	50	50	50	50	50
13.0	65	65	65	65	65	65	65	65
15.0	75	75	75	75	75	75	75	75
16.0	80	80	80	80	80	80	80	80
20.0	100	100	100	100	100	100	100	100
25.0	125	125	125	125	125	125	125	125
32.0	160	160	160	160	160	160	160	160
40.0	200	200	200	200	200	200	200	200
50.0	250	250	250	250	250	250	250	250
63.0	315	315	315	315	315	315	315	315
80.0	400	400	400	400	400	400	400	400
100.0	500	500	500	500	500	500	500	500
125.0	625	625	625	625	625	625	625	625

A.4 Line safety switch, tripping characteristic C

Range of instantaneous tripping: $5 - 10 \times I_N$

Nominal current [A]	Disconnection time [s]							
	0.035	0.04	0.07	0.1	0.2	0.4	1	5
	Minimum prospective short-circuit current [A]							
0.5	5	5	5	5	5	5	5	2.7
1.0	10	10	10	10	10	10	10	5.4
1.6	16	16	16	16	16	16	16	8.6
2.0	20	20	20	20	20	20	20	10.8
4.0	40	40	40	40	40	40	40	21.6
6.0	60	60	60	60	60	60	60	32.4
8.0	80	80	80	80	80	80	80	43.2
10.0	100	100	100	100	100	100	100	54.0
13.0	130	130	130	130	130	130	130	70.2
15.0	150	150	150	150	150	150	150	83.0
16.0	160	160	160	160	160	160	160	86.4
20.0	200	200	200	200	200	200	200	108.0
25.0	250	250	250	250	250	250	250	135.0
32.0	320	320	320	320	320	320	320	172.8
40.0	400	400	400	400	400	400	400	216.0
50.0	500	500	500	500	500	500	500	270.0
63.0	630	630	630	630	630	630	630	340.2
80.0	800	800	800	800	800	800	800	432.0
100.0	1 000	1 000	1 000	1 000	1 000	1 000	1 000	540.0
125.0	1 250	1 250	1 250	1 250	1 250	1 250	1 250	675.0

A.5 Line safety switch, tripping characteristic K

Range of instantaneous tripping: $8 - 14 \times I_N$

Nominal current [A]	Disconnection time [s]							
	0.035	0.04	0.07	0.1	0.2	0.4	1	5
	Minimum prospective short-circuit current [A]							
0.5	7.5	7.5	7.5	7.5	7.5	7.5	7.5	7.0
1.0	15.0	15.0	15.0	15.0	15.0	15.0	15.0	14.0
1.6	24.0	24.0	24.0	24.0	24.0	24.0	24.0	22.4
2.0	30.0	30.0	30.0	30.0	30.0	30.0	30.0	28.0
4.0	60.0	60.0	60.0	60.0	60.0	60.0	60.0	56.0
6.0	90.0	90.0	90.0	90.0	90.0	90.0	90.0	84.0
10.0	150.0	150.0	150.0	150.0	150.0	150.0	150.0	140.0
13.0	195.0	195.0	195.0	195.0	195.0	195.0	195.0	182.0
15.0	225.0	225.0	225.0	225.0	225.0	225.0	225.0	210.0
16.0	240.0	240.0	240.0	240.0	240.0	240.0	240.0	224.0
20.0	300.0	300.0	300.0	300.0	300.0	300.0	300.0	280.0
25.0	375.0	375.0	375.0	375.0	375.0	375.0	375.0	350.0
32.0	480.0	480.0	480.0	480.0	480.0	480.0	480.0	448.0
40.0	600.0	600.0	600.0	600.0	600.0	600.0	600.0	460.0
50.0	750.0	750.0	750.0	750.0	750.0	750.0	750.0	700.0
63.0	945.0	945.0	945.0	945.0	945.0	945.0	945.0	882.0
80.0	1 200.0	1 200.0	1 200.0	1 200.0	1 200.0	1 200.0	1 200.0	1 120.0
100.0	1 500.0	1 500.0	1 500.0	1 500.0	1 500.0	1 500.0	1 500.0	1 400.0
125.0	1 875.0	1 875.0	1 875.0	1 875.0	1 875.0	1 875.0	1 875.0	1 750.0

A.6 Line safety switch, tripping characteristic D

Range of instantaneous tripping: $10 - 20 \times I_N$

Nominal current [A]	Disconnection time [s]							
	0.035	0.04	0.07	0.1	0.2	0.4	1	5
	Minimum prospective short-circuit current [A]							
0.5	10	10	10	10	10	10	6.5	2.7
1.0	20	20	20	20	20	20	13.0	5.4
1.6	32	32	32	32	32	32	20.8	8.6
2.0	40	40	40	40	40	40	26.0	10.8
4.0	80	80	80	80	80	80	52.0	21.6
6.0	120	120	120	120	120	120	78.0	32.4
8.0	160	160	160	160	160	160	104.0	43.2
10.0	200	200	200	200	200	200	130.0	54.0
13.0	260	260	260	260	260	260	169.0	70.2
15.0	300	300	300	300	300	300	195.0	81.0
16.0	320	320	320	320	320	320	208.0	86.4
20.0	400	400	400	400	400	400	260.0	108.0
25.0	500	500	500	500	500	500	325.0	135.0
32.0	640	640	640	640	640	640	416.0	172.8
40.0	800	800	800	800	800	800	520.0	216.0
50.0	1 000	1 000	1 000	1 000	1 000	1 000	650.0	270.0
63.0	1 260	1 260	1 260	1 260	1 260	1 260	819.0	340.2
80.0	1 600	1 600	1 600	1 600	1 600	1 600	1 040.0	432.0
100.0	2 000	2 000	2 000	2 000	2 000	2 000	1 300.0	540.0
125.0	2 500	2 500	2 500	2 500	2 500	2 500	1 625.0	675.0

A.7 Line safety switch, tripping characteristic Z

Range of instantaneous tripping: $2 - 3 \times I_N$

Nominal current [A]	Disconnection time [s]							
	0.035	0.04	0.07	0.1	0.2	0.4	1	5
	Minimum prospective short-circuit current [A]							
3	9	9	9	9	9	9	9	9
4	12	12	12	12	12	12	12	12
6	18	18	18	18	18	18	18	18
8	24	24	24	24	24	24	24	24
10	30	30	30	30	30	30	30	30
13	39	39	39	39	39	39	39	39
15	45	45	45	45	45	45	45	45
16	48	48	48	48	48	48	48	48
20	60	60	60	60	60	60	60	60
25	75	75	75	75	75	75	75	75
32	96	96	96	96	96	96	96	96
40	120	120	120	120	120	120	120	120
50	150	150	150	150	150	150	150	150
63	189	189	189	189	189	189	189	189
80	240	240	240	240	240	240	240	240
100	300	300	300	300	300	300	300	300
125	375	375	375	375	375	375	375	375

A.8 Line safety switch, tripping characteristic L

Range of instantaneous tripping: $3.5 - 5 \times I_N$

Nominal current [A]	Disconnection time [s]							
	0.035	0.04	0.07	0.1	0.2	0.4	1	5
	Minimum prospective short-circuit current [A]							
1.6	8.4	8.4	8.4	8.4	8.4	8.4	8.4	8.4
2.0	10.5	10.5	10.5	10.5	10.5	10.5	10.5	10.5
4.0	21.0	21.0	21.0	21.0	21.0	21.0	21.0	21.0
6.0	31.5	31.5	31.5	31.5	31.5	31.5	31.5	31.5
10.0	52.5	52.5	52.5	52.5	52.5	52.5	52.5	52.5
12.0	63.0	63.0	63.0	63.0	63.0	63.0	63.0	63.0
13.0	68.3	68.3	68.3	68.3	68.3	68.3	68.3	68.3
15.0	78.8	78.8	78.8	78.8	78.8	78.8	78.8	78.8
16.0	84.0	84.0	84.0	84.0	84.0	84.0	84.0	84.0
20.0	105.0	105.0	105.0	105.0	105.0	105.0	105.0	105.0
25.0	131.3	131.3	131.3	131.3	131.3	131.3	131.3	131.3
32.0	168.0	168.0	168.0	168.0	168.0	168.0	168.0	168.0
40.0	210.0	210.0	210.0	210.0	210.0	210.0	210.0	210.0
50.0	262.5	262.5	262.5	262.5	262.5	262.5	262.5	262.5
63.0	330.8	330.8	330.8	330.8	330.8	330.8	330.8	330.8

A.9 Line safety switch, tripping characteristic U

Range of instantaneous tripping: $5.5 - 12 \times I_N$

Nominal current [A]	Disconnection time [s]							
	0.035	0.04	0.07	0.1	0.2	0.4	1	5
	Minimum prospective short-circuit current [A]							
1.0	12.0	12.0	12.0	12.0	12.0	12.0	12.0	9.0
1.6	19.2	19.2	19.2	19.2	19.2	19.2	19.2	14.4
2.0	24.0	24.0	24.0	24.0	24.0	24.0	24.0	18.0
4.0	48.0	48.0	48.0	48.0	48.0	48.0	48.0	36.0
6.0	72.0	72.0	72.0	72.0	72.0	72.0	72.0	54.0
10.0	120.0	120.0	120.0	120.0	120.0	120.0	120.0	90.0
12.0	144.0	144.0	144.0	144.0	144.0	144.0	144.0	108.0
13.0	156.0	156.0	156.0	156.0	156.0	156.0	156.0	117.0
15.0	180.0	180.0	180.0	180.0	180.0	180.0	180.0	135.0
16.0	192.0	192.0	192.0	192.0	192.0	192.0	192.0	144.0
20.0	240.0	240.0	240.0	240.0	240.0	240.0	240.0	180.0
25.0	300.0	300.0	300.0	300.0	300.0	300.0	300.0	225.0
32.0	384.0	384.0	384.0	384.0	384.0	384.0	384.0	288.0
40.0	480.0	480.0	480.0	480.0	480.0	480.0	480.0	360.0
50.0	600.0	600.0	600.0	600.0	600.0	600.0	600.0	450.0
63.0	756.0	756.0	756.0	756.0	756.0	756.0	756.0	567.0

Appendix B Standard and optional accessories for specific measuring functions

The table below lists recommended standard and optional accessories required for specific measurements. Please refer to chapter 3.5 for further information on standard and optional accessories.

Measuring function	Appropriate accessories (accessories with item no. are optional)
Insulating resistance	<ul style="list-style-type: none"> <input type="checkbox"/> universal three-wire test cable <input type="checkbox"/> "Commander" test probe switchable by means of "TEST" key (044155)
Low-impedance resistance Continuity test	<ul style="list-style-type: none"> <input type="checkbox"/> universal three-wire test cable <input type="checkbox"/> "Commander" test probe switchable by means of "TEST" key (044155) <input type="checkbox"/> 40 m measuring line BENNING TA 5 (044039)
Line impedance (voltage drop) Loop impedance	<ul style="list-style-type: none"> <input type="checkbox"/> universal three-wire test cable <input type="checkbox"/> test cable with shock-proof plug <input type="checkbox"/> "Commander" test plug for shock-proof socket switchable by means of "TEST" key(044155) <input type="checkbox"/> "Commander" test probe switchable by means of "TEST" key (044155)
RCD testing	<ul style="list-style-type: none"> <input type="checkbox"/> universal three-wire test cable <input type="checkbox"/> test cable with shock-proof plug <input type="checkbox"/> "Commander" test plug for shock-proof socket (switchable by means of "TEST" key) (044149)
Earthing resistance	<ul style="list-style-type: none"> <input type="checkbox"/> universal three-wire test cable <input type="checkbox"/> earthing kit consisting of two earth rods, three test cables (044113)
Phase sequence (rotary field)	<ul style="list-style-type: none"> <input type="checkbox"/> universal three-wire test cable <input type="checkbox"/> 16 A CEE measuring adapter, 5-pin, for voltage / rotary field measurement (044148)
Voltage, frequency	<ul style="list-style-type: none"> <input type="checkbox"/> universal three-wire test cable <input type="checkbox"/> "Commander" test probe switchable by means of "TEST" key (044155) <input type="checkbox"/> test cable with shock-proof plug <input type="checkbox"/> "Commander" test plug for shock-proof socket (switchable by means of "TEST" key) (044149)
Current (IT 130)	<ul style="list-style-type: none"> <input type="checkbox"/> AC current clamp adapter BENNING CC 1 for current measurement up to 400 A AC (044037) <input type="checkbox"/> AC / DC current clamp adapter BENNING CC 3 for current measurement up to 300 A AC / DC (044038)
Luminous intensity (IT 130)	<ul style="list-style-type: none"> <input type="checkbox"/> luminous intensity sensor BENNING luxmeter type B (044111)
Single-fault leakage current (ISFL) in IT networks (IT 130)	<ul style="list-style-type: none"> <input type="checkbox"/> universal three-wire test cable <input type="checkbox"/> test cable with shock-proof plug <input type="checkbox"/> "Commander" test plug for shock-proof socket (switchable by means of "TEST" key) (044149) <input type="checkbox"/> "Commander" test probe switchable by means of "TEST" key (044155)

Appendix C Optional "Commander" test probe, "Commander" test plug

C.1 Safety warnings

Measuring categories of the "Commanders"

"Commander" test probe switchable by means of "TEST" key (044155)

without attachable protective cap, 18 mm tip: CAT II 1000 V to earth

with attachable protective cap, 4 mm tip: CAT II 1000 V / CAT III 600 V / CAT IV 300 V to earth

Optional accessories:

"Commander" test plug for shock-proof socket (switchable by means of "TEST" key)

Item no.: 044149 CAT II 300 V to earth

- ❑ The measuring categories of the "Commanders" might be lower than the measuring category of the device.
- ❑ If the phase voltage is detected at the protective conductor connection (PE), immediately stop all measurements and make sure that the fault will be eliminated.
- ❑ Before replacing the batteries / storage batteries or opening the battery compartment cover, disconnect the "Commander" both from the device and from the installation.
- ❑ For repairs or service, please contact your specialty retailer or the BENNING Service Center.

C.2 Batteries

The "Commanders" can be operated with of two alkaline batteries or two rechargeable NiMh batteries (storage batteries) of size AAA. The usual operating time is approximately 40 hours and shall apply to a capacity of at least 850 mAh.

Notes:

- ❑ If the "Commanders" are not used for a longer period of time, remove all batteries / storage batteries from the battery compartment.
- ❑ Use alkaline batteries or rechargeable NiMh batteries of size AAA only! When using rechargeable storage batteries, it is recommended to observe a minimum capacity of 850 mAh.
- ❑ Please make sure that the batteries / storage batteries are inserted with correct polarity, because otherwise the "Commander" cannot be operated and the batteries / storage batteries will discharge.

C.3 Description of the "Commanders"



Figure C.1: Front of "Commander" test probe switchable by means of "TEST" key (044155)

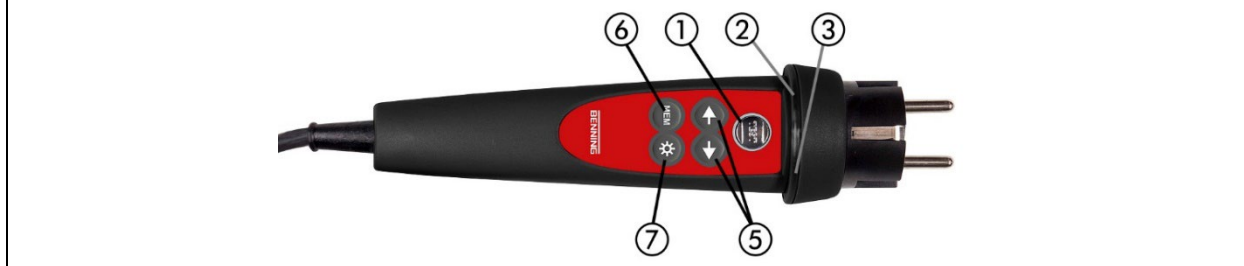

Figure C.2: Front of the optional "Commander" test plug for shock-proof socket switchable by means of "TEST" key (044149)

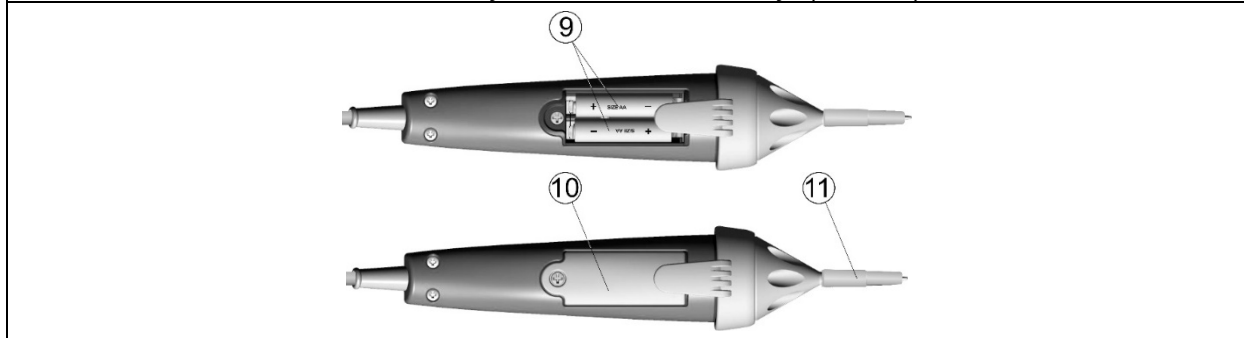

Figure C.3: Rear of the "Commander" test probe

Caption:

1	TEST	Start of measurement PE contact electrode for protective conductor connection
2	LED	Left status RGB LED
3	LED	Right status RGB LED
4	LEDs	LEDs of the measuring point illumination
5	Function selector keys (IT 130)	Selection of the measuring function (only in the "AUTO" switch position)
6	MEM (IT 130)	Storage / recall of measuring results
7	LCD illumination	Switches on / off the LCD illumination of the device
8	Measuring point illumination (IT 130)	Switches on / off the measuring point illumination
9	Batteries / storage batteries	Size AAA, alkaline batteries or NiMH storage batteries
10	Battery compartment cover	Battery compartment cover
11	Protective cap	Detachable protective cap, CAT IV 300 V

C.4 LED indications of the "Commanders"

Both LEDs yellow	Warning! Phase voltage at the PE connection of the "Commander"! Only indicated, if the silver "TEST" key of the "Commander" is touched for > 1 second!
Right LED red	Measuring result outside the preset limiting values
Right LED green	Measuring result inside the preset limiting values
Left LED is flashing blue	"Commander" is monitoring the input voltage
Left LED orange	Voltage between testing terminals is higher than 50 V
Both LEDs are flashing red	Battery voltage of the "Commander" is low
Both LEDs red and "Commander" switches off	Battery voltage too low to operate the "Commander"

How to test the protective conductor connection (PE)

- ❑ Select the **Z_L (L-N/L)** (English: Z_{LINE}), **Z_S (L-PE)** (English: Z_{LOOP}) or **FI/RCD** function by means of the function selector switch.
- ❑ Connect the optional "Commander" test plug (044149) to the test object (see figure C.4).
- ❑ Touch the silver contact electrode of the "TEST" key at the "Commander" for at least one second.
- ❑ If the phase voltage is detected at the PE connection of the "Commander", the LEDs of the "Commander" will light yellow. In addition, the  warning is shown on the LC display of the device and the buzzer sounds. Further measurements must be stopped immediately!

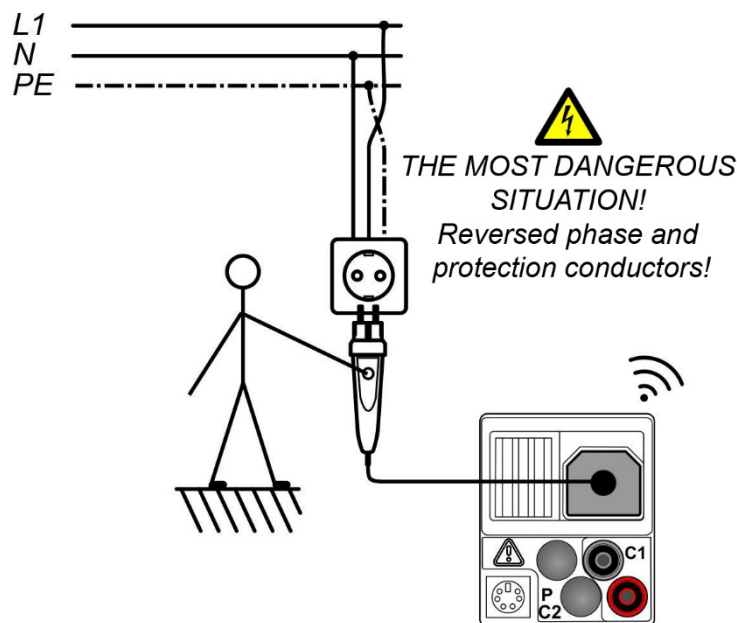

Figure C.4: Reversed L and PE conductors – Phase voltage at the PE connection is detected by touching the "TEST" key of the optional "Commander" test plug (044149).
- Figure using the IT 130 as an example