

BENNING

Operating manual

Translation of the German original version

BENNING IT 100

5225 / 08/2023 en



Legal notice

Notes concerning the documentation

Ensure that the applicable documentation is used for this product. For safe handling, knowledge that is provided in these instructions is required.

The product may only be handled while following this documentation, particularly the safety instructions and warnings it contains. The personnel must be qualified for the respective task and have the capability to recognise risks and prevent possible dangers.

Manufacturer and holder of rights

BENNING Elektrotechnik und Elektronik GmbH & Co. KG
Münsterstraße 135 – 137
46397 Bocholt
Germany
Phone: +49 2871 / 93-0
E-Mail: duspol@benning.de
Internet: www.benning.de
Commercial register Coesfeld HRA No. 4661

Copyright

© 2022, BENNING Elektrotechnik und Elektronik GmbH & Co. KG
All rights reserved.

This document – particularly all of the contents, texts, photographs and graphics that it contains – are protected by copyright.

No part of this documentation or the associated contents may be reproduced or edited, copied or distributed using electronic media in any form (printed, photocopied or using any other method) without express written permission.

Disclaimer

The contents of the documentation has been checked to ensure that it corresponds to the hardware and software described. Nevertheless, deviations cannot be ruled out, so Benning cannot guarantee complete correspondence. The contents of this documentation are checked at regular intervals, and any corrections that are needed are contained in the versions that follow.

General non-discrimination

Benning is aware of the importance of language with regard to the gender equality and endeavors to take this into account at all times. To improve readability, we have refrained from consistently using differentiating formulations.

Table of contents

1	Introduction	7
1.1	General notes.....	7
1.2	History.....	8
1.3	Service & support.....	9
2	Safety	10
2.1	Warning system.....	10
2.2	Standards applied.....	10
2.3	Symbols used.....	11
2.4	Intended use.....	12
2.5	Special types of risks.....	14
3	Scope of delivery	15
4	Device description	17
4.1	Device structure.....	17
4.2	Functions.....	20
4.2.1	“TEST” key.....	20
4.2.2	High-voltage warning light.....	20
4.2.3	Display illumination key.....	20
4.2.4	“LOCK” key.....	21
4.2.5	Blue key.....	21
4.2.6	“PI DAR” key.....	21
4.3	Measuring ranges.....	21
4.3.1	Voltage ranges.....	22
4.3.2	Resistance ranges.....	22
5	Operation	24
5.1	Requirements for tests and measurements.....	24
5.2	Connecting the safety measuring lines.....	25
5.3	Voltage measurement.....	26
5.4	Resistance measurement or continuity test.....	27
5.5	Low-resistance measurement.....	28
5.6	Insulating resistance measurement.....	29
5.7	Measuring the polarisation index (PI) or the dielectric absorption ratio (DAR).....	31
6	Maintenance	33
6.1	Maintenance schedule.....	33
6.2	Making the device free of voltage.....	33
6.3	Testing the fuse.....	34

6.4	Cleaning the device.....	35
6.5	Replacing the batteries	36
6.6	Calibrating the device.....	37
6.7	Replacing the fuse	37
7	Technical data.....	38
8	Disposal and environmental protection	39
	Index	40

Table of figures

Figure 1	BENNING TA 1	15
Figure 2	BENNING TA 2	15
Figure 3	BENNING TA 3	16
Figure 4	Ø 4 mm measuring lines with 2 mm measuring probe	16
Figure 5	BENNING IT 100 device structure	17
Figure 6	Rotary switch	18
Figure 7	Digital display	19
Figure 8	Voltage measurement	26
Figure 9	Resistance measurement	27
Figure 10	Low-resistance measurement	28
Figure 11	Insulating resistance measurement	30
Figure 12	Testing the fuse	34
Figure 13	Battery replacement (exemplary)	36

List of tables

Table 1	History.....	8
Table 2	Symbols on the device.....	11
Table 3	Symbols used in the operating manual.....	11
Table 4	Description of symbols on the digital display	19
Table 5	AC voltage ranges (V-AC)	22
Table 6	DC voltage ranges (V-DC).....	22
Table 7	Measuring ranges for resistance measurement (Ω)	22
Table 8	Measuring ranges for low-resistance measurement (Ω).....	23
Table 9	Measuring ranges for insulating resistance measurement (Ω)	23
Table 10	Maintenance schedule	33
Table 11	Technical data	38

1 Introduction

The insulation and resistance measuring device BENNING IT 100 described here (in the following only referred to as “device”) is intended for testing in circuits with a nominal voltage up to a maximum of 600 V-AC or 600 V-DC. The device enables you to perform the following tests and measurements:

- DC and AC voltage measurement
- Resistance measurement
- Continuity test
- Low-resistance measurement
- Insulating resistance measurement
- Measuring / calculating the polarisation index (PI)
- Measuring / calculating the dielectric absorption ratio (DAR)

Further information

<http://tms.benning.de/it100>



On the Internet, you will find the following additional information directly at the specified link or at www.benning.de (product search):

- Operating manual of the device in several languages
- Further information depending on the device (e. g. brochures, technical reports, FAQs)

1.1 General notes

Target group

This operating manual is intended for the following groups of people:

- Qualified electricians and electrotechnically trained personnel

Required basic knowledge

To understand these operating manual, you will need general knowledge of testing and measuring equipment. Moreover, you will need basic knowledge of the following issues:

- General electrical engineering

Purpose of the operating manual

This operating manual describes the device and provides you information about how to handle it.

Keep this operating manual in a safe place for later use. Read this operating manual before handling the device and follow the instructions.

NOTE

Disclaimer of liability

Please make sure that any person using the device has read and understood the instructions of this operating manual before handling the device and that the instructions are adhered to in all points. Non-observance of this operating manual might result in product damage, property damage and/or personal injury.

Benning assumes no liability for damage and malfunctions resulting from the failure to observe the instructions in this operating manual.

The devices are subject to continuous further development. Benning reserves the right to make changes to the device's design, configuration and technology. The information in this operating manual corresponds to the state of technical knowledge at the time of printing. For this reason, no claims for certain device characteristics can be derived from the contents of this operating manual.

Information in this operating manual can be changed at any time without prior notice. Benning is not obligated to make amendments to this operating manual or to keep it up to date.

Direct any technical questions to Technical Support [▶ page 9].

Trademarks

All trademarks used are the property of their respective owners, even if they are not separately marked as such.

1.2 History

Release number	Amendments
04/2022	• Initial release
08/2023	• Revision of the operating manual

Table 1: History

1.3 Service & support

Please contact your specialty retailer or the BENNING Service Center for any repair or service work that might be required.

Technical Support

Please contact our Technical support for technical questions on handling the device.

Phone:	+49 2871 93-555
Fax:	+49 2871 93-6555
E-Mail:	helpdesk@benning.de
Internet:	www.benning.de

Returns management

Easily and conveniently use the BENNING returns portal for a quick and smooth returns processing:

<https://www.benning.de/service-de/retourenabwicklung.html>

Phone:	+49 2871 93-554
E-Mail:	returns@benning.de

Return address

BENNING Elektrotechnik und Elektronik GmbH & Co. KG
Retourenmanagement
Robert-Bosch-Str. 20
D - 46397 Bocholt

2 Safety

2.1 Warning system

This operating manual contains notes that must be taken into consideration for your personal safety and in order to avoid injuries and damage to property. Warnings about your personal safety and to prevent personal injuries are marked with a warning triangle. Warnings on sole prevention of material damage are shown without a warning triangle. The warnings are shown in descending order depending on the hazard level as follows.



⚠ DANGER

Extremely dangerous situation for humans

If you do not pay attention to this warning, irreversible or deadly injuries will occur.



⚠ WARNING

Hazard to humans

If you do not pay attention to this warning, irreversible or deadly injuries could occur.



⚠ CAUTION

Minor hazard to humans

If you do not pay attention to this warning, minor or moderate injuries could occur.



NOTICE

Danger to property, not to persons

If you do not pay attention to this warning, material damage could occur.

If multiple hazard levels occur, the warning for the highest respective hazard level will be used. In addition, a warning about personal injuries can also include a warning about material damage.

2.2 Standards applied

The device has been built and tested in compliance with the following standards and has left the factory in perfectly safe condition.

- IEC / DIN EN 61010-1 (VDE 0411-1)
- IEC / DIN EN 61010-2-030 (VDE 0411-2-030)
- IEC / DIN EN 61557-2 (VDE 0413-2)
- IEC / DIN EN 61557-4 (VDE 0413-4)
- IEC / DIN EN 61557-10 (VDE 0413-10)

2.3 Symbols used

Symbols on the device













Symbol	Meaning
	Please observe the information provided in this operating manual in order to avoid dangers.
	Warning of electrical danger! Please observe the information provided in this operating manual in order to avoid dangers.
CAT IV	Measuring category IV is applicable to testing and measuring circuits connected to the feeding point of the low-voltage mains installation of a building.
	The device complies with EU directives.
	At the end of product life, dispose of the unserviceable device via appropriate collecting facilities provided in your community.
	The device is provided with protective insulation (protection class II).
	This symbol indicates the built-in fuse.
	This symbol indicates the inserted batteries.
	Please observe the operating manual.
	(DC) direct voltage or direct current
	(AC) alternating voltage or alternating current
	Earth (voltage to earth)
	Do not use the device in distribution networks with voltages >660 V.

Table 2: Symbols on the device

Symbols used in the operating manual



Symbol	Meaning
	General warning
	Warning of electric voltage!

Table 3: Symbols used in the operating manual

2.4 Intended use

Only use the device within the framework of the corresponding technical data. Any operating conditions that deviate from this shall be considered as improper use. Solely the user of the device shall be liable for any resulting damage.

Please note the following:

- In case of improper use, the liability and warranty claims become void. Solely the user of the device shall be liable for any damage resulting from improper use. Uses not complying with the intended use include e. g.:
 - Use of components, accessories, spare or replacement parts that have not been released and approved for the respective application by Benning
 - Non-observance, manipulation, changes or misuse of the operating manual or the instructions and notes contained therein
 - Any form of misuse of the device
 - Any use other than or beyond that described in this operating manual
- Warranty and liability claims are generally excluded if the damage is the result of force majeure.
- If any prescribed services are not performed regularly or not on time, according to the manufacturer's specifications during the warranty period, a decision about a warranty claim can only be made once the findings are available.

Direct any questions to Technical Support [▶ page 9].

Using the device

Please observe the following basic obligations when using the device:

- The device may only be used in a technically perfect and safe condition. Always check the device for damages before using it.
- The personnel must be qualified for the respective task.
- Observe relevant regulations on occupational safety and health as well as those on environmental protection.
- The device may only be used inside buildings and in dry environments.
- Do not use the device in potentially explosive environments.
- Use the device only in electric circuits up to overvoltage category CAT IV with a conductor for a maximum of 600 V to earth.
- Use suitable (approved) safety measuring lines. For measurements in electric circuits of overvoltage category CAT III or IV, the protruding conductive part of a contact tip of the safety measuring line must not be longer than 4 mm. Before measuring, attach the enclosed protective caps onto the contact tips (marked with CAT III and CAT IV).
- In order to prevent any danger due to incorrect measurements, replace discharged batteries immediately.
- In order to prevent any danger, replace a defective fuse immediately.
- In order to avoid mechanical damage, use the device with the protective rubber holster in place.
- The measuring point must be free of voltage before the safety measuring lines are applied – except for voltage measurements.

**⚠ WARNING****Dangerous voltage**

Danger to life or serious injury is possible due to contact with high electric voltage in case of incorrect operation.

- Do not touch the bare measuring probe tips of the safety measuring lines or the bare contacts of the optional alligator clips, Only touch the safety measuring lines in the area intended for your hands.
- Please note that dangerous testing voltages might be present at the device during insulating resistance measurement. These might also be applied to the measuring circuit if safety measuring lines are contacted.
- Connect the safety measuring lines to the correspondingly marked measuring jacks of the device and check them for tight fit.
- Only use approved safety measuring lines.
- Attach the protective caps to the contact tips of the safety measuring lines (circuits of overvoltage category CAT III or IV).
- When disconnecting the measuring circuit, first remove the live safety measuring line (phase) and then the neutral safety measuring line from the measuring point.

**⚠ WARNING****Opening the device**

Danger to life or serious injury is possible due to contact with high electric voltage when opening the device. The device might get damaged.

- Make sure that the device is free of voltage before opening the battery compartment.
- Do not open the device (except for the battery compartment).
- Please contact your specialty retailer or the returns management for any repairs [[▶ page 9](#)].

Securing the device

If the device is not in a technically perfect and operationally safe condition, safe operation is no longer guaranteed. Make sure that the following measures are taken:

- Switch off the device.
- Remove the device from the measuring point.
- Secure the device against unintentional operation.

The following characteristics indicate that safe operation is no longer guaranteed:

- The device (housing or safety measuring lines) shows visible damage or is damp/wet.
- The insulation of the safety measuring lines is damaged.
- The device does not work properly in compliance with regulations (e. g. errors during measurements).
- The device shows recognisable consequences of prolonged storage under inadmissible conditions.
- The device shows recognisable consequences of extraordinary stress due to transport.

2.5 Special types of risks



DANGER

Bare conductors or main line carriers

Danger to life or serious injury is possible due to contact with high electric voltage when working with bare conductors or main line carriers.

- Please observe relevant regulations on occupational safety and health.
- If necessary, use appropriate protective equipment.



WARNING

Dangerous voltage

Danger to life or serious injury is possible due to contact with high electric voltage when working on live components or equipment. Even low voltages from 30 V-AC and 60 V-DC on can be dangerous to human life!

- Please observe relevant regulations on occupational safety and health.
- If necessary, use appropriate protective equipment.

3 Scope of delivery

The scope of delivery of the device includes the following components:

- 1 x BENNING IT 100 insulation and resistance measuring device
- Set of safety measuring lines (item no.: 10230645)
 - Set of \varnothing 4 mm safety measuring lines, 6-piece, red / black, professional version, consisting of:
 - 2 x measuring lines
 - 2 x test probes
 - 2 x alligator clips
- 1 x compact protective pouch (item no: 10230646)
- 4 x 1.5 V alkaline batteries (AA / IEC LR6, NEDA 15 A)
- 1 x fuse (FF 315 mA, 1 000 V, 10 kA, integrated into the device for initial assembly)
- 1 x operating manual

Optional accessories

- Set of safety measuring lines BENNING TA 1 (item no.: 044124)
 - \varnothing 4 mm alligator clips, 2-piece, red / black, professional version, CAT III 1 000 V, 36 A



Figure 1: BENNING TA 1

- Set of safety measuring lines BENNING TA 2 (item no.: 044125)
 - Set of \varnothing 4 mm measuring lines, 6-piece, red / black, professional version, consisting of:
 - Measuring lines (silicone) (CAT III 1 000 V)
 - Test probes (4 mm measuring probe, CAT II 1 000 V)
 - Alligator clips (CAT III 1 000 V)



Figure 2: BENNING TA 2

- Set of safety measuring lines BENNING TA 3 (item no.: 044126)
Set of Ø 4 mm measuring lines, 8-piece, red / black, professional version, CAT III 1 000 V, consisting of:
 - Measuring lines (silicone)
 - Test probes (slender measuring probe)
 - Grabber clips
 - Alligator clips



Figure 3: BENNING TA 3

- Set of Ø 4 mm safety measuring lines with 2 mm measuring probe (item no.: 044146)
Ø 4 mm measuring lines, 2-piece, red / black, l = 1.40 m, with 2 mm measuring probe, CAT IV 600 V / CAT III 1 000 V (with protective caps), CAT II 1 000 V (without protective caps)



Figure 4: Ø 4 mm measuring lines with 2 mm measuring probe

4 Device description

4.1 Device structure

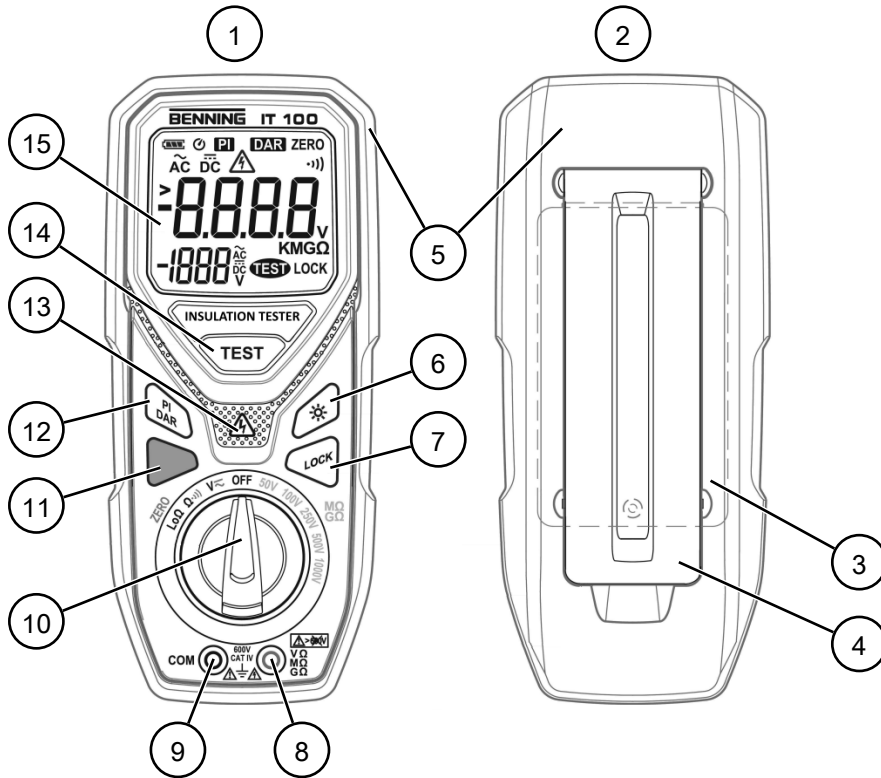

Figure 5: BENNING IT 100 device structure

1	Front panel of the device	2	Rear panel of the device
3	Battery compartment cover	4	Foldable stand
5	Protective rubber holster	6	Display illumination key
7	“LOCK” key	8	“+” jack
9	COM jack	10	Rotary switch
11	Blue key	12	“PI DAR” key
13	Red LED (high-voltage control indicator)	14	“TEST” key
15	Digital display		

Rear panel of the device

- Foldable stand
- Battery compartment
- Label on the battery compartment cover with notes and information about the device
- Serial number (label)

Rotary switch

You can set the desired test or measurement by means of the rotary switch.

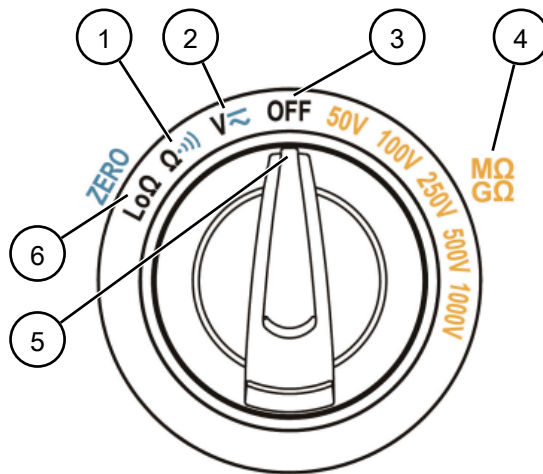

Figure 6: Rotary switch

1	Resistance measurement or continuity test	2	Voltage measurement
3	Device switched off	4	Insulating resistance measurement with selected voltage value
5	Setting of the rotary switch	6	Low-resistance measurement or null balance

Digital display

The digital display is divided into different sections:

- Display of functions, units, dangerous contact voltage and battery status
- Display range for measured value: 4-digit liquid crystal display (LCD) with a font size of 19 mm and decimal points. The highest display value is 9 999 digits.
- Display range for testing voltage: 3,5-digit liquid crystal display (LCD) with a font size of 11 mm. The highest display value is 1 999 digits.
- Polarity display (automatic): Indicates a polarity contrary to the jack definition with “-”.
- Indication of the measuring range being exceeded (“>”): In this case, the displayed measured value does not correspond to the actual value, but to the maximum value for the selected measuring range.

The background lighting of the digital display can be switched on or off by means of the display illumination key.

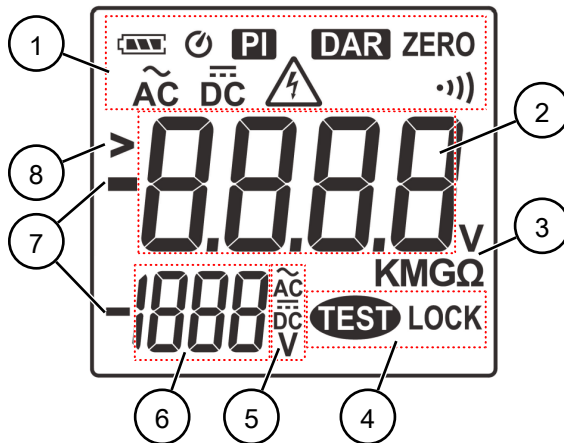

Figure 7: Digital display

1	Display of functions, dangerous contact voltage and battery status	2	Display range for measured value
3	Unit of the measured value	4	Display of functions
5	Type and unit of testing voltage	6	Display range for testing voltage
7	Polarity	8	Measured value outside measuring range

Description of symbols:

Symbol	Description
	Battery status: Indicates the state of charge of the batteries (max. 3 segments). The batteries are discharged as soon as all segments have disappeared.
	Auto-Power-OFF
PI	Polarisation index measurement enabled
DAR	Dielectric absorption ratio measurement enabled
ZERO	Null balance enabled
	AC voltage measurement enabled
	DC voltage measurement enabled
	High-voltage control indicator: Appears if the device detects the presence of a dangerous voltage (>2 V-AC / V-DC or >30 V-AC / V-DC depending on the measuring function).
	Continuity test enabled
TEST	Testing voltage applied (during low-resistance or insulating resistance measurement)
LOCK	“LOCK” function enabled

Table 4: Description of symbols on the digital display

4.2 Functions

Use the rotary switch to switch the device on (desired measuring function) or off (“OFF”).

The device confirms each operation of keys and the rotary switch with an acoustic signal. Invalid keystrokes are confirmed with a double beep. The device switches off automatically after approx. 10 minutes (APO, Auto-Power-Off). Please note that during a low-resistance or insulating resistance measurement the timer is disabled (e. g. when the “LOCK” function is enabled). To switch the device back on after an Auto-Power-Off, first set the rotary switch to switch position “OFF” and then set the desired measuring function.

4.2.1 “TEST” key

Press the “TEST” key to start the corresponding measurement depending on the switch position of the rotary switch and to stop it depending on the measuring function (e. g. when the “LOCK” function is enabled). By pressing and holding the “TEST” key, the respective measurement remains enabled until the key is released.

- Low-resistance measurement
- Insulating resistance measurement

- Insulating resistance

The device outputs a high testing voltage during the measurement and measures the insulating resistance with this testing voltage.

- Polarisation index (PI)

- Dielectric absorption ratio (DAR)

4.2.2 High-voltage warning light

The high-voltage warning light is a red LED and lights up in the following cases:

- The device detects the presence of a dangerous voltage (depending on the measuring function):
 - Insulating resistance measurement: >30 V-AC / V-DC
 - Low-resistance measurement: >2 V-AC / V-DC
 - Voltage measurement: >30 V-AC / V-DC
- The batteries are discharged.

In addition, the high-voltage control indicator is shown on the digital display.

4.2.3 Display illumination key

Press the display illumination key to switch the background lighting of the digital display on or off. When switching it on, you can choose between 2 functions. It is possible at any time to switch the background lighting off manually.

- Press once: The background lighting switches off automatically after 30 seconds.
- Press and hold for approx. 2 seconds (confirmation by another acoustic signal): The background lighting remains switched on until Auto-Power-Off.

4.2.4 “LOCK” key

By pressing the “LOCK” key, you can enable the “LOCK” function prior to a low-resistance or insulating resistance measurement. If the “LOCK” function is enabled, a subsequent low-resistance or insulating resistance measurement started with the “TEST” key will remain active until it is stopped by pressing the “TEST” or “LOCK” key. During the measurements, a testing current (low-resistance measurement) or a testing voltage (insulating resistance measurement) is continuously applied at the measuring point.

If the “LOCK” function is disabled, the device can detect an inadmissible external voltage and prevent a low-resistance or insulating resistance measurement if necessary. If the “LOCK” function is enabled, the device can no longer detect an inadmissible external voltage.



NOTICE

Undetected inadmissible external voltage

The fuse of the device might blow because of an undetected inadmissible external voltage due to the “LOCK” function being enabled.

- Make sure that the measuring point is free of voltage.

4.2.5 Blue key

Press the blue key to toggle between the standard function of the rotary switch position and the secondary function in blue colour.

- Resistance measurement or continuity test: Toggling between the functions
- Low-resistance measurement or null balance (ZERO): Toggling between the functions
The “ZERO” function is intended for a null balance of the safety measuring lines. After having performed the null balance, the device automatically switches back to low-resistance measurement.
- Voltage measurement: Toggling between DC and AC voltage measurement

4.2.6 “PI DAR” key

Press the “PI DAR” key to toggle between insulating resistance measurement, polarisation index (PI) measurement and dielectric absorption ratio (DAR) measurement in the corresponding rotary switch position.

4.3 Measuring ranges

The device is provided with an automatic switch-over of the measuring range. For this reason, a default setting is not required.

The symbol “>” indicates that a measuring range has been exceeded. In case of contact voltages from 30 V-DC or 2 V-AC on, the red LED (high-voltage control indicator) lights additionally.

Measuring accuracy

The measuring accuracy is specified as the sum of the following:

- Relative part of the measured value
- Number of digits (counting steps of the last digit)

The stated measuring accuracy is specified for 1 % to 100 % of the final measuring range value and applies at a temperature of 23 °C ±5 °C and a relative air humidity lower than 80 %. In case of deviating temperatures, observe the temperature coefficient by adding the following value to the specified measuring accuracy:

$$0.2 [1/^\circ\text{C}] \times \text{specified measuring accuracy} \times \text{difference to reference temperature range } [^\circ\text{C}]$$

4.3.1 Voltage ranges

AC voltage ranges (V-AC)

Overload protection: 600 V-AC / V-DC

Measuring range	Resolution	Measuring accuracy
60 V	0.01 V	±(2 % + 5 digits)
600 V	0.1 V	

Table 5: AC voltage ranges (V-AC)

- Frequency range: 45 ... 500 Hz

DC voltage ranges (V-DC)

Overload protection: 600 V-AC / V-DC

Measuring range	Resolution	Measuring accuracy
60 V	0.01 V	±(2 % + 5 digits)
600 V	0.1 V	

Table 6: DC voltage ranges (V-DC)

4.3.2 Resistance ranges

Measuring ranges for resistance measurement

Overload protection: 600 V-AC / V-DC

Measuring range	Resolution	Measuring accuracy
600 Ω	0.1 Ω	±(2 % + 5 digits)
6 kΩ	0.001 kΩ	
60 kΩ	0.01 kΩ	
600 kΩ	0.1 kΩ	

Table 7: Measuring ranges for resistance measurement (Ω)

Measuring ranges for continuity test

Overload protection: 600 V-AC / V-DC

- Measuring range: 600 Ω
- Resolution: 0.1 Ω
- The integrated buzzer sounds at a resistance lower than 4 ... 14 Ω .
- Buzzer response time: <100 ms

Measuring ranges for low-resistance measurement

Overload protection: 600 V-AC / V-DC

Measuring range	Resolution	Measuring accuracy
6 Ω	0.01 Ω	$\pm(2\% + 3 \text{ digits})$
60 Ω	0.1 Ω	

Table 8: Measuring ranges for low-resistance measurement (Ω)

- Measuring range according to EN 61557: 0.1 ... 60 Ω
- Testing voltage: >4 V and <8 V
- Short-circuit current: >200 mA
- Detection of a connected electric circuit: If the external voltage is >2 V-AC / V-DC, the test will be prevented.

Measuring ranges for insulating resistance measurement

Testing voltage	Measuring range	Measuring accuracy	Resistance	
			min. (for 1 mA)	max.
50 V	300 k Ω / 3 M Ω / 30 M Ω / 300 M Ω / 1 G Ω	$\pm(3\% + 5 \text{ digits})$ (30 k Ω ... 1 G Ω)	50 k Ω	1 G Ω
100 V	600 k Ω / 6 M Ω / 60 M Ω / 600 M Ω / 2 G Ω	$\pm(3\% + 5 \text{ digits})$ (60 k Ω ... 2 G Ω)	100 k Ω	2 G Ω
250 V	1.5 M Ω / 15 M Ω / 150 M Ω / 1.5 G Ω	$\pm(3\% + 5 \text{ digits})$ (150 k Ω ... 1.5 G Ω)	250 k Ω	5 G Ω
	5 G Ω	$\pm(10\% + 3 \text{ digits})$		
500 V	3 M Ω / 30 M Ω / 300 M Ω / 3 G Ω	$\pm(3\% + 5 \text{ digits})$ (300 k Ω ... 3 G Ω)	500 k Ω	10 G Ω
	10 G Ω	$\pm(10\% + 3 \text{ digits})$		
1 000 V	6 M Ω / 60 M Ω / 600 M Ω / 6 G Ω	$\pm(3\% + 5 \text{ digits})$ (600 k Ω ... 6 G Ω)	1 M Ω	20 G Ω
	20 G Ω	$\pm(10\% + 3 \text{ digits})$		

Table 9: Measuring ranges for insulating resistance measurement (Ω)

- Accuracy of testing voltage: 0 ... 20 %
- Short-circuit current: 1 mA
- Detection of a connected electric circuit: If the external voltage is >30 V-AC / V-DC, the test will be prevented.

5 Operation

The device enables you to carry out various tests and measurements.

5.1 Requirements for tests and measurements

Please observe the following basic requirements for tests and measurements:

- Remove the device (safety measuring lines) from the measuring point before setting a switch position on the rotary switch of the device.
- Only use approved safety measuring lines [► page 25].
- Please consider sources of interference that might be present. Strong sources of interference in the vicinity of the device might involve unstable readings and measuring errors.
- For carrying out the tests and measurements, please observe the associated measuring ranges and measuring accuracies stated in the chapter “Measuring ranges” [► page 21].



DANGER

Maximum admissible voltage

Danger to life or serious injury is possible due to contact with high electric voltage.

- Use the device only in electric circuits up to overvoltage category CAT IV with a conductor for a maximum of 600 V to earth.

5.2 Connecting the safety measuring lines

For tests and measurements, it is necessary to connect the safety measuring lines to the device.

Requirements

- Please observe the requirements for measuring [► page 24].
- Safety measuring lines
The safety measuring lines must be approved for the device (e. g. safety measuring lines included in the scope of delivery) and be in a technically perfect and operationally safe condition.
 - Check the specifications regarding nominal voltage and nominal current.
 - Check the insulation of the safety measuring lines.
 - Check the safety measuring lines for continuity.
 - Replace defective safety measuring lines.
- Protective caps (depending on the overvoltage category)
- During tests and measurements, only touch the safety measuring lines in the area intended for your hands.



⚠ WARNING

Dangerous voltage

Danger to life or serious injury is possible due to contact with high electric voltage in case of incorrect operation.

- Do not touch the bare measuring probe tips of the safety measuring lines or the bare contacts of the optional alligator clips, Only touch the safety measuring lines in the area intended for your hands.
- Please note that dangerous testing voltages might be present at the device during insulating resistance measurement. These might also be applied to the measuring circuit if safety measuring lines are contacted.
- Connect the safety measuring lines to the correspondingly marked measuring jacks of the device and check them for tight fit.
- Only use approved safety measuring lines.
- Attach the protective caps to the contact tips of the safety measuring lines (circuits of overvoltage category CAT III or IV).
- When disconnecting the measuring circuit, first remove the live safety measuring line (phase) and then the neutral safety measuring line from the measuring point.

Procedure

1. Remove the end caps from both ends of the safety measuring lines and keep them in a safe place. Reinsert the end caps into the safety measuring lines after completing the tests and measurements.
2. Plug the test probes or alligator clips onto the safety measuring lines. Make sure that the colours match (black or red).
3. Connect the black safety measuring line to the COM jack of the device.
4. Connect the red safety measuring line to the “+” jack of the device.
5. Measurements or tests with test probes in circuits of overvoltage category CAT III or IV: Attach the protective caps to the contact tips of the safety measuring lines.

5.3 Voltage measurement

Requirements

- Please observe the requirements for measuring [▶ page 24].
- Approved safety measuring lines
- Voltage ranges [▶ page 22]

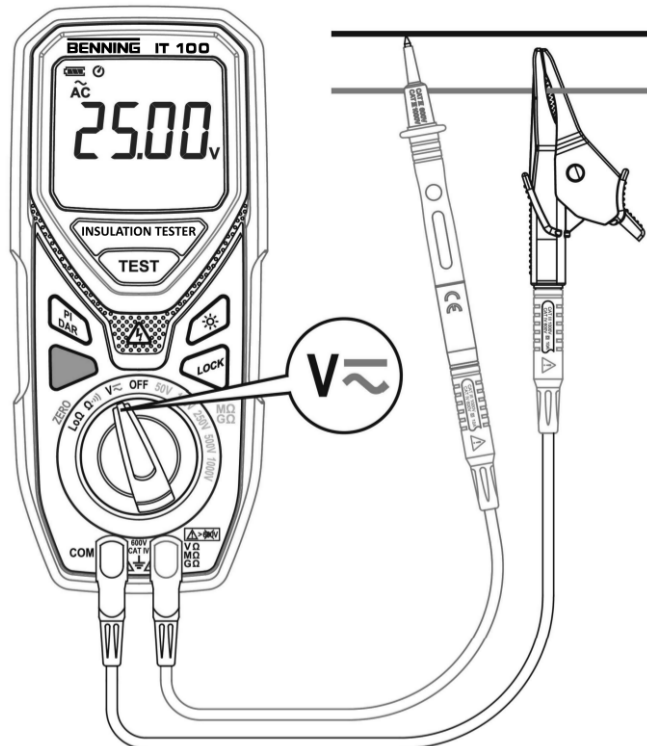

Figure 8: Voltage measurement

Procedure

1. Set the rotary switch of the device to switch position " $V \sim$ ".
2. Press the blue key to set the desired measuring function (AC or DC voltage).
3. Connect the safety measuring lines to the device [▶ page 25].
4. Bring the safety measuring lines into contact with the measuring points and read the measured value on the digital display.

5.4 Resistance measurement or continuity test

Requirements

- Please observe the requirements for measuring [▶ page 24].
- Approved safety measuring lines
- Measuring ranges for resistance measurement [▶ page 22] or continuity test [▶ page 23]
- Measuring point must be free of voltage

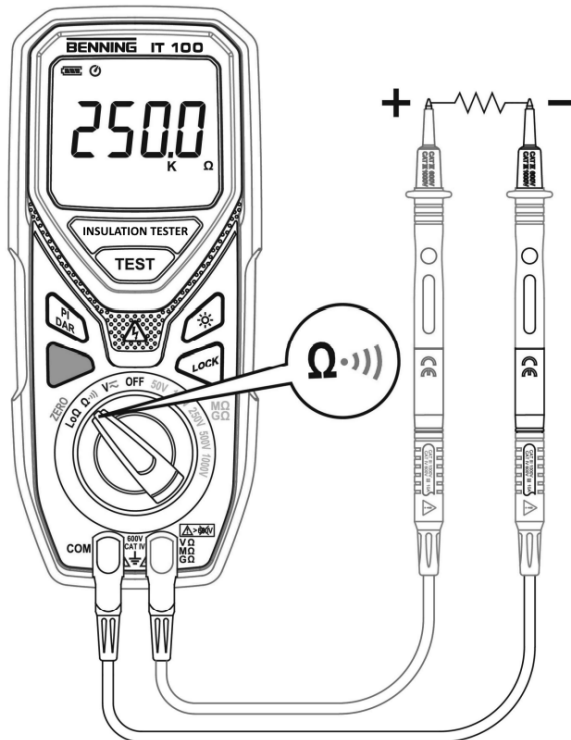

Figure 9: Resistance measurement

Procedure

1. Set the rotary switch of the device to switch position “ Ω ·)))”.
2. Press the blue key to set the desired measuring function (resistance measurement or continuity test).
3. Connect the safety measuring lines to the device [▶ page 25].
4. Bring the safety measuring lines into contact with the measuring points and read the measured value on the digital display.

5.5 Low-resistance measurement

Requirements

- Please observe the requirements for measuring [▶ page 24].
- Approved safety measuring lines
- Measuring ranges for low-resistance measurement [▶ page 23]
- Fuse has been tested [▶ page 34]
- Measuring point must be free of voltage



NOTICE

Undetected inadmissible external voltage

The fuse of the device might blow because of an undetected inadmissible external voltage due to the "LOCK" function being enabled.

- Make sure that the measuring point is free of voltage.

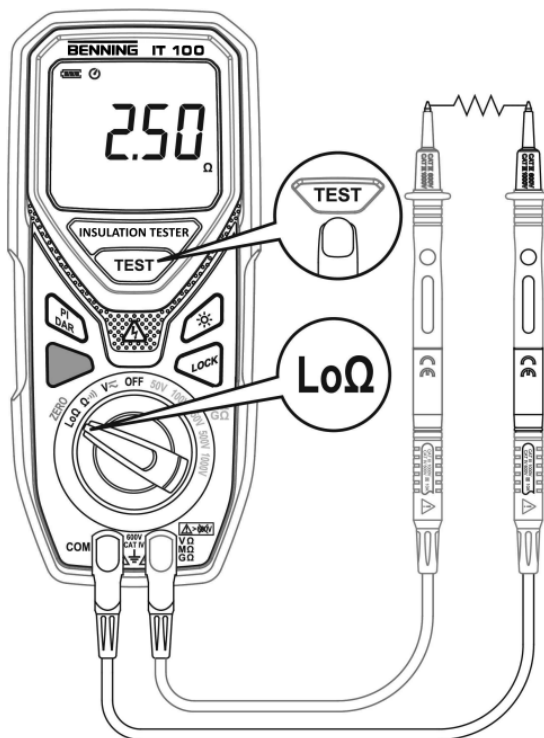

Figure 10: Low-resistance measurement

Procedure

1. Set the rotary switch of the device to switch position "Lo Ω ".
2. Connect the safety measuring lines to the device [▶ page 25].
3. Only for new safety measuring lines: Briefly short-circuit the two measuring probes of the safety measuring lines by contacting them and start the null balance by pressing the blue key.
After successful null balance, "ZERO" is shown on the digital display. Please note that the resistance to be compensated must not exceed 2 Ω .
4. Bring the safety measuring lines into contact with the measuring points.
5. Press and hold the "TEST" key until the measured value is shown on the digital display.
 - As long as you keep the "TEST" key pressed, the measurement is active and the displayed measured value may change.
 - During an active measurement, "TEST" is shown on the digital display.
 - The measured value will be displayed until a new test is started or another rotary switch position is set.
 - In case of four acoustic signals being emitted, the measurement was not successful and the measurement has to be started again.
 - Alternatively, you can also use the "LOCK" function [▶ page 21].
6. Read the measured value on the digital display.
Please note that if the measured value is outside the measuring range, the ">" symbol will be displayed. In this case, the displayed measured value does not correspond to the actual value, but to the maximum value of the measuring range.

5.6 Insulating resistance measurement

Requirements

- Please observe the requirements for measuring [▶ page 24].
- Approved safety measuring lines
- Measuring ranges for insulating resistance measurement [▶ page 23]
- Fuse has been tested [▶ page 34]
- Measuring point must be free of voltage



⚠ WARNING

Dangerous voltage

Danger to life or serious injury is possible due to contact with high electric voltage in case of incorrect operation. During insulating resistance measurement, dangerous testing voltages might be present at the device. These might also be applied to the measuring circuit if safety measuring lines are contacted.

- Do not touch the bare measuring probe tips of the safety measuring lines or the bare contacts of the optional alligator clips, Only touch the safety measuring lines in the area intended for your hands.



NOTICE

Undetected inadmissible external voltage

The fuse of the device might blow because of an undetected inadmissible external voltage due to the “LOCK” function being enabled.

- Make sure that the measuring point is free of voltage.

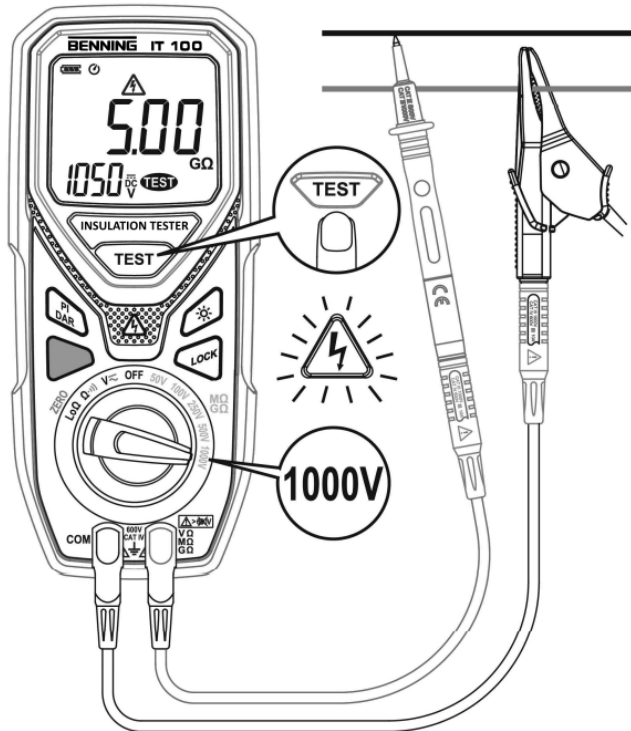

Figure 11: Insulating resistance measurement

Procedure

1. Set the desired testing voltage on the rotary switch of the device.
2. Connect the safety measuring lines to the device [▶ page 25].
3. Bring the safety measuring lines into contact with the measuring points.
4. Press and hold the “TEST” key until the measured value and the actual testing voltage are shown on the digital display.
 - As long as you keep the “TEST” key pressed, the measurement is active and the displayed measured value as well as the actual testing voltage may change.
 - During an active measurement, “TEST” is shown on the digital display.
 - The measured value will be displayed until a new test is started or another rotary switch position is set.
 - In case of four acoustic signals being emitted, the measurement was not successful and the measurement has to be started again.
 - Alternatively, you can also use the “LOCK” function [▶ page 21] .
5. Read the measured value on the digital display.
6. Please note the following before removing the safety measuring lines from the measuring points: To discharge internal energy storages of the measuring circuit via the device, release the “TEST” key before removing the safety measuring lines and wait until the testing voltage has returned to 0 V.

5.7 Measuring the polarisation index (PI) or the dielectric absorption ratio (DAR)

Requirements

- Please observe the requirements for measuring [▶ page 24].
- Approved safety measuring lines
- Measuring ranges for insulating resistance measurement [▶ page 23]
- Fuse has been tested [▶ page 34]
- Measuring point must be free of voltage



⚠ WARNING

Dangerous voltage

Danger to life or serious injury is possible due to contact with high electric voltage in case of incorrect operation. During insulating resistance measurement, dangerous testing voltages might be present at the device. These might also be applied to the measuring circuit if safety measuring lines are contacted.

- Do not touch the bare measuring probe tips of the safety measuring lines or the bare contacts of the optional alligator clips, Only touch the safety measuring lines in the area intended for your hands.

Polarisation index (PI)

Polarisation index (PI) = R10-min / R1-min

- R10-min: Measured insulating resistance after 10 minutes
- R1-min: Measured insulating resistance after 1 minute

Dielectric absorption ratio (DAR)

Dielectric absorption ratio (DAR) = R1-min / R30-sec

- R1-min: Measured insulating resistance after 1 minute
- R30-sec: Measured insulating resistance after 30 seconds

Procedure

1. Set the desired testing voltage on the rotary switch of the device.
2. Connect the safety measuring lines to the device [► page 25].
Due to the long measuring duration, the use of the alligator clips is recommended.
3. Bring the safety measuring lines into contact with the measuring points.
4. Press the blue key to set the desired measuring function (PI or DAR).
5. Press the “TEST” key to start the measurement.
 - When the measurement is active, the currently measured value, the actual testing voltage and “TEST” are shown on the digital display.
 - In case of four acoustic signals being emitted, the measurement was not successful and the measurement has to be started again.
 - The measurement continues until the measured values for calculating the PI or DAR value have been measured and the PI or DAR value is shown on the digital display.
 - Press the “TEST” key again to stop the measurement prematurely.
6. Read the calculated PI or DAR value on the digital display. If a measured value used to calculate these values is outside the measuring range, “Err” will be shown on the digital display.

Note: A polarisation index >2 or a dielectric absorption ratio >1.3 are characteristic for an excellent insulation quality.
7. Please note the following before removing the safety measuring lines from the measuring points: To discharge internal energy storages of the measuring circuit via the device, release the “TEST” key before removing the safety measuring lines and wait until the testing voltage has returned to 0 V.

6 Maintenance

The battery compartment may be opened for maintenance work. Apart from that, there are no components in the device that you can replace.



WARNING

Opening the device

Danger to life or serious injury is possible due to contact with high electric voltage when opening the device. The device might get damaged.

- Make sure that the device is free of voltage before opening the battery compartment.
- Do not open the device (except for the battery compartment).
- Please contact your specialty retailer or the returns management for any repairs [[▶ page 9](#)].

6.1 Maintenance schedule

The following table provides an overview of all maintenance and servicing work that you must carry out permanently or at regular intervals.

Interval	Measures
Before each low-resistance and insulating resistance measurement	<ul style="list-style-type: none"> • Testing the fuse [▶ page 34]
Regularly, as needed	<ul style="list-style-type: none"> • Cleaning the device [▶ page 35]
As needed	<ul style="list-style-type: none"> • Replacing the batteries [▶ page 36]
Every 12 months	<ul style="list-style-type: none"> • Calibrating the device [▶ page 37]

Table 10: Maintenance schedule

6.2 Making the device free of voltage

If you want to open the battery compartment for maintenance work, make sure first that the device is free of voltage.

Procedure

1. Remove the device from the measuring point.
2. Disconnect the safety measuring lines from the device.
3. Set the rotary switch of the device to switch position "OFF".

6.3 Testing the fuse

The device is protected against overload by means of a fuse. Only use the device with the fuse being functional.

Requirements

- Voltage-free device [▶ page 33]

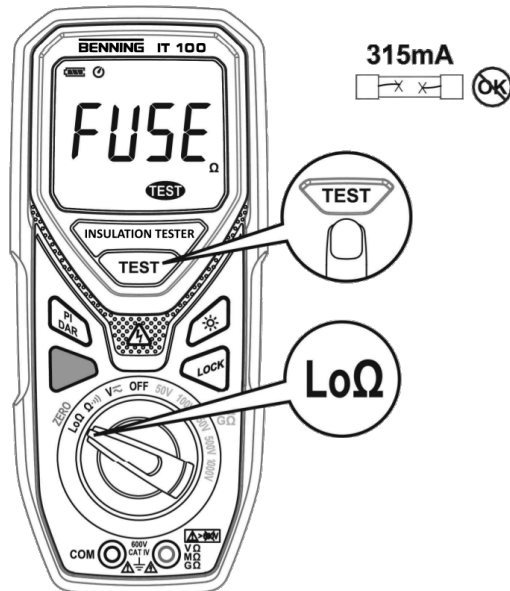

Figure 12: Testing the fuse

Procedure

1. Set the rotary switch of the device to switch position “LoΩ”.
2. Press and hold the “TEST” key until a measured value or “FUSE” is shown on the digital display.

While pressing and holding the key, “TEST” is shown on the digital display and the value in the display area is initially reset (“- - -”).

- Measured value: The fuse is functional and you can carry out a low-resistance or insulating resistance measurement.
- “FUSE”: The fuse is defective. Please replace it [▶ page 37].

6.4 Cleaning the device

Clean the device regularly and as the need arises. Make sure that the battery compartment and the battery contacts are not contaminated by leaking battery electrolyte.

Requirements

- A clean and dry cloth or special cleaning cloth
- Voltage-free device [[▶ page 33](#)]



NOTICE

Wrong cleaning agents

Using the wrong cleaning agents can damage the device.

- Do not use any solvents, abrasives or polishing agents.

Procedure

1. Clean the exterior of the device with a clean and dry cloth or a special cleaning cloth.
2. Check the battery compartment. To open and close the battery compartment, follow the procedure given in the chapter “Replacing the batteries” [[▶ page 36](#)].
3. In case of electrolyte contamination or white deposits in the area of the battery or the battery compartment, clean the batteries and these areas by means of a clean and dry cloth. Replace the batteries, if necessary [[▶ page 36](#)].

6.5 Replacing the batteries

The device is powered by batteries. Replace the batteries as soon as they are discharged.

Requirements

- Discharged batteries inside the device (all segments of the battery symbol on the digital display have disappeared, the high-voltage warning light is on and “*batt*” is shown on the digital display)
- 4 new 1.5 V mignon batteries (AA)
- Voltage-free device [▶ page 33]
- Suitable Phillips screwdriver

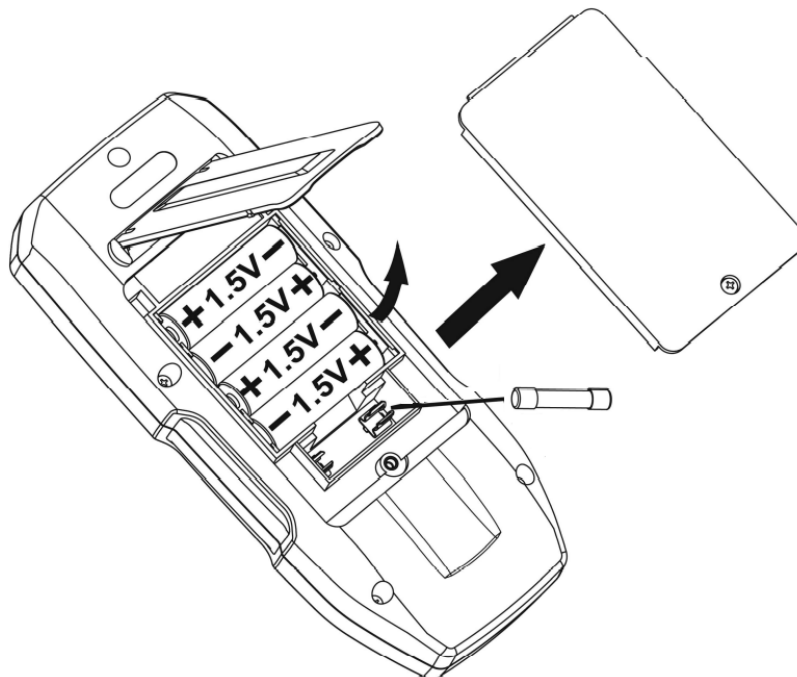

Figure 13: Battery replacement (exemplary)

Procedure

1. Remove the protective rubber holster. To do this, proceed as follows:
 - Hold the device with both hands and press the rubber lip sideways over the edge of the device with your thumbs at the two front upper corners of the device.
 - Pull the protective rubber holster backwards off the device.
2. Place the device face down (onto an anti-slip surface).
3. Unfold the stand and keep it unfolded.
4. Unscrew the screw of the battery compartment cover.
5. Lift the battery compartment cover off the device.
6. Remove the discharged batteries from the battery compartment and dispose of them properly [▶ page 39].
7. Insert the new batteries into the battery compartment observing the correct polarity.
8. Place the battery compartment cover back onto the device and tighten the screw.
9. Put the protective rubber holster back onto the device.

6.6 Calibrating the device

Benning guarantees compliance with this technical and accuracy specifications stated in this operating manual for the first 12 months after the delivery date.

To maintain accuracy of the measuring results, make sure that the device is recalibrated in annual intervals by the BENNING Service [► page 9].

<http://calibration.benning.de>



6.7 Replacing the fuse

The device is protected against overload by means of a fuse. Replace the fuse if it is defective.

Requirements

- New fuse (FF 315 mA, 1 000 V, 10 kA, d = 6.3 mm, l = 32 mm, e. g. item no. 757213)
- Voltage-free device [► page 33]
- Slotted screwdriver and suitable Phillips screwdriver
- Open battery compartment cover (for this, see the procedure for replacing the batteries [► page 36])

Procedure

1. Laterally lift one end of the defective fuse off the fuse holder by means of a slotted screwdriver.
2. Remove the defective fuse from the fuse holder and dispose of it properly [► page 39].
3. Insert the new fuse and position it centrally in the fuse holder.
4. Place the battery compartment cover back onto the device and tighten the screw.
5. Put the protective rubber holster back onto the device.

7 Technical data

Protection class	II (double or reinforced insulation)
Contamination level	2
Protection category (DIN VDE 0470-1, IEC / EN 60529)	IP 40 1st digit: 4 = protection against access to dangerous parts and protection against solid impurities (diameter >1.0 mm) 2nd digit: 0 = no protection against water
Overvoltage category	<ul style="list-style-type: none"> CAT IV 600 V to earth
Housing dimensions (length x width x height)	206 mm x 90 mm x 51 mm
Weight (batteries and protective rubber holster included)	0.51 kg
Battery life (alkaline batteries)	<ul style="list-style-type: none"> Approx. 2 600 low-resistance measurements acc. to IEC / DIN EN 61557-4 (1 Ω, with a measuring duration of 5 s) <p>or</p> <ul style="list-style-type: none"> Approx. 1 200 insulating resistance measurements acc. to IEC / DIN EN 61557-2 (1 MΩ, at 1 000 V and with a measuring duration of 5 s)
Set of safety measuring lines (item no.: 10230645)	
Standard	IEC / DIN EN 61010-031 (VDE 0411-031)
Overvoltage category (only applies to the safety measuring lines, additionally observe the limitations of the device)	<ul style="list-style-type: none"> With attachable protective cap or alligator clip: <ul style="list-style-type: none"> CAT III 1 000 V to earth CAT IV 600 V to earth Without attachable protective cap: <ul style="list-style-type: none"> CAT II 1 000 V to earth
Protection class	II (double or reinforced insulation)
Contamination level	2
Max. rated current	10 A
Length	1.3 m
Operation	
Max. barometric altitude	2 000 m
Operating temperature	0 ... 40 °C (do not permanently expose the device to sunlight)
Max. relative air humidity	80 % RH (0 ... 40 °C), non-condensing
Operating conditions	To be used inside buildings in dry environments
Storage (remove the batteries from the device)	
Ambient temperature	-10 ... 60 °C (do not permanently expose the device to sunlight)
Max. relative air humidity	80 % RH

Table 11: Technical data

8 Disposal and environmental protection



At the end of product life, dispose of the unserviceable device and the batteries via appropriate collecting facilities provided in your community.

Index

A		K	
AC voltage ranges (V-AC)	22	Key	
Accessories	15	Blue	21
B		Display illumination	20
Basic knowledge	7	LOCK	21
Battery		PI DAR	21
Replacing	36	TEST	20
BENNING IT 100	7	L	
C		Low-resistance measurement	29
Calibrating	37	M	
Cleaning	35	Maintenance	33
Continuity testing	27	Maintenance schedule	33
Copyright	2	Manufacturer	2
D		Measurement	
DC voltage ranges (V-DC)	22	Requirements	24
Device		Measuring accuracy	22
Calibrating	37	Measuring ranges	21
Cleaning	35	AC voltage ranges (V-AC)	22
Securing	13	Continuity test	23
Device structure	17	DC voltage ranges (V-DC)	22
Dielectric absorption ratio (DAR)	31	Insulating resistance measurement	23
Digital display	18	Low-resistance measurement	23
Disclaimer	2, 12	Resistance measurement	22
Disposal	39	Measuring the dielectric absorption ratio (DAR)	32
Documentation	2	Measuring the polarisation index (PI)	32
E		N	
Environmental protection	39	Non-discrimination	2
F		O	
Further information	7	Operation	24
Fuse		P	
Replacing	37	Polarisation index (PI)	31
Testing	34	Purpose of the operating manual	8
H		R	
High-voltage	20	Rear panel of the device	17
High-voltage warning light	20	Resistance measurement	27
History	8	Return address	9
Holder of rights	2	Returns management	9
I		Rotary switch	18
Insulating resistance measurement	30	S	
Intended use	12	Safety measuring lines	
IT 100	7	Connecting	25
		Scope of delivery	15

Securing	13
Service & Support	
Technical Support	9
Standards applied	10
Symbols	
Device	11
Operating manual	11

T

Target group	7
Technical data	38
Technical Support	9
Test	
Requirements	24
Trademarks	8

V

Voltage measurement	26
Voltage-free	33

W

Warning system	10
Warranty	12

BENNING

BENNING Elektrotechnik und Elektronik GmbH & Co. KG
Münsterstraße 135 - 137
D - 46397 Bocholt
Phone: +49 2871 93-0 Fax: +49 2871 93-429
Internet: www.benning.de E-Mail: duspol@benning.de

The text and illustrations correspond to the state of technology at the time of printing. Subject to technical changes. No liability accepted for printing errors.